

VERSION 5  
NOVEMBER 2009

**2009**

# Guidelines



**EACS**

European AIDS Clinical Society

The European AIDS Clinical Society (EACS) is a not-for-profit group of European physicians, clinicians and researchers in the field of HIV/ AIDS.

It aims to bring together scientists from all over Europe to help exchange the latest medical and scientific knowledge regarding clinical aspects of HIV/ AIDS and its complications.

**Executive Committee Members:**

Peter Reiss ( <i>President</i> ) Amsterdam, The Netherlands	Anna Maria Geretti London, United Kingdom
--	--

Manuel Battegay ( <i>Vice President</i> ) Basel, Switzerland	Christine Katlama Paris, France
---	------------------------------------

Nathan Clumeck ( <i>Treasurer</i> ) Brussels, Belgium	Jens Lundgren Copenhagen, Denmark
--	--------------------------------------

Fiona Mulcahy ( <i>Secretary</i> ) Dublin, Ireland	Anton Pozniak London, United Kingdom
---	---

José Arribas Madrid, Spain	Jürgen Rockstroh Bonn, Germany
-------------------------------	-----------------------------------

Antonella d'Arminio-Monforte Milan, Italy	Mike Youle London, United Kingdom
--	--------------------------------------

José Gatell Barcelona, Spain	
---------------------------------	--

European AIDS Clinical Society

**Guidelines**  
Clinical Management and Treatment  
of HIV Infected Adults in Europe



## Index

• Panel members . . . . .	6
• Abbreviations used throughout this document . . . . .	7
• Assessment of HIV Infected Patients at Initial and Subsequent Visits. . . . .	8
• Assessing and supporting patients' readiness to start ART . . . . .	10
• Comments to the table Start of ART and patients' readiness . . . . .	12
• Primary HIV infection (PHI) . . . . .	13
• Recommendations for Initiation of Therapy in Naive HIV-Infected Patients . . . . .	14
• Initial Combination Regimen for Antiretroviral-Naïve patient . . . . .	15
• HAART in TB/HIV coinfection . . . . .	16
• Switch strategies for virologically suppressed patients . . . . .	17
• Virological Failure . . . . .	18
• Treatment of HIV Pregnant Women . . . . .	20
• Post-Exposure Prophylaxis . . . . .	22

## Panel Members

Nathan Clumeck,  
Chair, Brussels, *Belgium*

Nikos Dedes,  
Athens, *Greece*

Anton Pozniak,  
London, *United Kingdom*

François Raffi,  
Nantes, *France*

*and the EACS Executive Committee*

## Abbreviations used throughout this document

- ABC=abacavir
- ART=antiretroviral therapy
- ATV=atazanavir
- CVD=cardiovascular disease
- d4T=stavudine
- ddI=didanosine
- DRV=darunavir
- EFV=efavirenz
- ETR = etravirine
- FDC=Fixed Dose Combination
- HBV=hepatitis B virus
- HCV=hepatitis C virus
- HDL-c=HDL-cholesterol
- IDV=indinavir
- IHD=ischemic heart disease
- LDL-c=LDL-cholesterol
- LPV=lopinavir
- MVC maraviroc
- NFV=nelfinavir
- NNRTI=non-nucleoside reverse transcriptase inhibitors
- NRTI=nucleos(t)ide reverse transcriptase inhibitors
- NVP=nevirapine
- PI=protease inhibitors
- PI/r=protease inhibitors pharmacologically boosted with ritonavir
- RAL raltegravir
- RTV=ritonavir  
(if used as booster= /r)
- SQV=saquinavir
- TC=total cholesterol
- TDF=tenofovir
- TG=triglycerides
- TPV=tipranavir
- ZDV=zidovudine

## Assessment of HIV Infected Patients at Initial and Subsequent Visits

### INITIAL VISIT

- Complete medical history
- Physical examination, including height, weight, BMI, blood pressure, waist circumference
- Laboratory evaluation
  - Confirmation of HIV antibody positive
  - Plasma HIV RNA
  - Resistance testing (genotype) with determination of HIV subtype
  - CD4 absolute count + percentage (optional: CD8 and %)
  - Complete blood count, AST, ALT, Alk phosphatase, calcium, phosphate, glucose, creatinine, calculated creatinine clearance
  - Antibody tests for toxoplasma, CMV, Hepatitis A, B and C and syphilis
  - Fasting blood glucose and lipids including fasting total LDL & HDL cholesterol, and triglycerides (see metabolic guidelines)
  - Urine dipstick for protein and sugar
  - HLA B\*5701 determination (if available)
  - R5 tropism (if available)

- Cardiovascular risk assessment
- Sexually Transmitted Infection screen if appropriate
- Women: cervical pap smear
- Assessment of social and psychological condition: provide support and counselling if needed
- Consider HAV and HBV vaccination (depending on serology results) and pneumococcal vaccination
- PPD if CD4 above 400. Negative PPD does not exclude active or latent tuberculosis. T.SPOT.TB® (or QuantiFERON-TB Gold IT®) can be an alternative to PPD in selected high risk populations (if available)

### SUBSEQUENT VISITS

(Asymptomatic patients not receiving antiretroviral therapy)

- At least every 6 months
  - Complete blood count, CD4 count and %
  - Plasma HIV RNA
- Every year
  - Physical examination
  - Evaluation of social and psychological support,
  - Smoking cessation, diet evaluation

- Repeat serologic testing (syphilis, CMV, toxoplasmosis, hepatitis B, hepatitis C) if previously negative
- AST, ALT
- Women: cervical pap smear
- Fasting lipids
- Every 6 months
  - If cirrhosis (regardless of cause): alphafoetoprotein + ultrasound examination
- Treatment initiation
  - Assess and support patients' readiness to start combined ART (see specific Table)
  - Physical examination, including height, weight, BMI, blood pressure, waist circumference
  - Plasma HIV RNA
  - Resistance testing (genotype), if not yet obtained
  - CD4 count and % (optional: CD8 count and %)
  - Complete blood count, AST, ALT, bilirubin, creatinine, calculated creatinine clearance, calcium, phosphate
  - Fasting glucose and lipids
  - Urine dipstick for protein and sugar
  - Other laboratory parameters may be useful according to selected

- first-line regimen e.g. protein creatinine ratio, amylase, lipase
- Cardiovascular risk assessment
- Visits on therapy
  - Plasma HIV RNA
  - CD4 count and % (optional: CD8 count and %)
  - Complete blood count, creatinine, calculated creatinine clearance, AST, ALT bilirubin
  - Other laboratory parameters according to selected regimen
  - Fasting glucose and lipids

## “Assessing and supporting patients’ readiness to start ART“(1)

Goal: Facilitate decision making and starting ART for patients who qualify according to international guidelines.

<b>Before initiating ART, screen for decision making and adherence barriers:</b>	
<p><b>Patient related factors:</b></p> <p>A) Depression (2)</p> <p>B) Harmful alcohol or recreational drug use (3)</p> <p>C) Cognitive problems (4)</p> <p>D) Low health literacy</p>	<p><b>System related factors:</b></p> <p>E) Health insurance and drug supply</p> <p>F) Continuity of drug supply</p> <p>G) Social support and disclosure.</p>
<p>Recognise, discuss and reduce problems wherever possible!</p>	

Assess patients’ readiness and support progress between stages (6):  
 “I would like to talk about HIV-medication” <wants> “what do you think about it?” (6)

**Remember:**

- Set the agenda before every interview
- use open questions whenever possible
- use the WEMS-technique (7)

**Precontemplation:**

“I don’t need it, I feel good”  
 “I don’t want to think about it”

**Support:** Show respect for patient attitude / Try to understand health and therapy beliefs / Establish trust / Provide individualised short information / Schedule the next appointment.

**Contemplation: “I am weighing things up and feel torn about what to do about it”**

Restage again



**Preparation “I want to start, I think the drugs will allow me to live a normal life”**

Restage again



**Support:** Allow ambivalence / Support to weigh pros and cons together with patient / Assess information needs and support information seeking / Schedule the next appointment.

**Support:** Reinforce decision / Make shared decision on most convenient regimen / Educate: adherence, resistance, side effects / Discuss integration into daily life / Assess self-efficacy  
**Ask:** Do you think you can manage to take cART consistently once you have started?  
 Use: VAS 0-10 (8)

0 -----5 ----- 10

Patients presenting in the clinic may be at different stages of readiness: Precontemplation, contemplation or preparation [Transtheoretic model; Prochaska JO. Am Psychol 47:1102-1114, 1992]. The first step is to assess this stage, and then to support/intervene accordingly. An exception is if a patient presents late or very late, i.e. <200 or <50 CD4/µl. In this case the initiation of ART should not be delayed; the clinician should try to identify the most important adherence barriers which may be present, and support the patient to be prepared for prompt initiation of ART.”

**Consider skills training:**

- Medication-taking training, possibly MEMS (2-4wk) (9)
- Directly Observed Therapy with educational support
- Use aids: Pill boxes, cell phone alarm, involve contact persons where appropriate

**START AND MAINTAIN ADHERENCE**

**Screen:** For adherence problems in each meeting (10)  
**Support:** Discuss side effects, educate about surrogate markers, discuss integration of drug taking schedule

**Empower:** Give positive feedback

## Comments to the table Start of ART and patients' readiness <sup>(1)</sup>

- 1 This table should facilitate the initiation of ART. Matters for consideration listed in this table, such as decision making or barriers to adherence, have to be judged clinically in their context. For instance the clinician has to judge whether ART has to be initiated immediately despite the detection of possible barriers to adherence or whether delaying initiation is justified. Consider patient's cultural background.
- 2 Ask: "During the past month have you often been bothered by feeling down, depressed or hopeless?" "During the past month have you often been bothered by little interest or pleasure in doing things?" "Is this something with which you would like help?" If answers are positive, then sensitivity is 96%, specificity 89% (Arroll B et al. *BMJ* 327:1144-1146. 2003).
- 3 Ask: "Have you thought about Cutting down?" "Have you ever become Annoyed when people talk to you about your drinking?" "Have you ever felt Guilty about your drinking?" "Do you ever have a drink first thing in the morning (Eye opener)?" An affirmative answer to more than two CAGE-questions means a sensitivity and specificity for problematic alcohol use of more than 90% (Kitchens JM. *JAMA* 272(22): 1782-1787. 1994.). Ask similar questions for recreational drug use.
- 4 Ask: "Do you feel that you are having problems concentrating in your daily life?" "Do you feel slow in your thinking?" "Do you feel that you are having problems with your memory?" "Have relatives or friends expressed that they feel you are having problems with your memory or difficulty concentrating?"
- 5 Patients presenting in the clinic may be at different stages of readiness: Precontemplation, contemplation or preparation [Transtheoretic model; Prochaska JO. *Am Psychol* 47:1102- 1114, 1992]. The first step is to assess this stage, and then to support/intervene accordingly. An exception is if a patient presents late or very late, i.e. <200 or <50 CD4/ul. In this case the initiation of ART should not be delayed; the clinician should try to identify the most important adherence barriers which may be present, and support the patient to be prepared for prompt initiation of ART.
- 6 This is a suggested opening question to assess the patient's stage of readiness. Further discussion will indicate which of the three initial stages the patient has reached: he/she might even be ready for therapy.
- 7 WEMS: Waiting (>3sec), Echoing, Mirroring, Summarising (Langewitz W et al. *BMJ* 325:682-683. 2002).
- 8 VAS (= Visual Analogue Scale; Range from 0 to 10 i.e. 0 = I will not manage, 10 = I am sure I will manage).
- 9 Medication training/ MEMS training could be done with vitamins before starting ART.
- 10 Suggested adherence questions: "In the past 4 wks how often have you missed a dose of your HIV medication: every day, more than once a wk, once a wk, once every 2 wks, once a month, never?" "Have you missed more than one dose in a row?" (Glass TR et al. *Antiviral Therapy* 13(1):77-85. 2008).

*Adapted from: J. Fehr, D. Nicca, F. Raffi, R. Spirig, W. Langewitz, D. Haerry, M. Battegay, NEAT, 2008.*

## Primary HIV infection (PHI)

### Definition of Acute primary HIV infection

- High risk exposure within previous 2-8 weeks,
- and Clinical symptoms,
- and detectable HIV in the plasma (p24 Ag and/or HIV RNA > 10 000 c/ml)
- and negative or indeterminate serologic testing (negative or weakly positive ELISA, and WB ≤1 band)
- Recommendation: confirm HIV infection by HIV antibody test (WB) performed 3-6 weeks later.

### Treatment:

- Treatment indicated if:
  - AIDS defining events
  - Confirmed CD4 <350/mm<sup>3</sup> at month 3 or beyond
- Treatment should be considered if:
  - Severe illness/ prolonged symptoms (especially CNS symptoms)
- If treatment of PHI is considered, patient should be recruited into ongoing clinical trial
- Treatment optional, as indication relies only on theoretical considerations. In most situations, wait till month 6 (with CD4 and plasma HIV-RNA monitoring) and follow criteria for initiation of treatment in chronic HIV infection. Some experts recom-

mend treatment as a tool for prevention of HIV transmission.

Duration of treatment: unknown but maybe should be lifelong.

Maintain closer follow-up in case of treatment interruption

### Resistance testing:

- Recommended in all situations as soon as acute HIV infection is diagnosed, even if treatment not initiated
- In case it cannot be performed, store blood for further testing.

### Transmission:

- Recognize sexually transmitted infections (STIs), including syphilis, gonorrhoea, Chlamydia (Urethritis and LGV), HPV, hepatitis B and hepatitis C.
- Counsel newly diagnosed patient on high risk of transmission and preventive measures (condoms) including notifying and testing partners.

## Recommendations for Initiation of Therapy in Naive HIV-Infected Patients

<b>SYMPTOMATIC</b>	<ul style="list-style-type: none"> <li>• CDC stage B and C: treatment recommended</li> <li>• If OI, initiate as soon as possible*</li> </ul>
<b>ASYMPTOMATIC</b>	<ul style="list-style-type: none"> <li>• CD4 &lt; 200: Treatment recommended, without delay.</li> <li>• CD4 201-350: treatment recommended.</li> <li>• CD4 350-500:             <ul style="list-style-type: none"> <li>- Treatment recommended if hepatitis C co-infection, hepatitis B co-infection requiring therapy, HIV-associated nephropathy or other specific organ deficiency;</li> <li>- Treatment should be considered if VL&gt;10<sup>5</sup> c/ml and/or CD4 decline &gt;50-100/mm<sup>3</sup>/year or age &gt;50 or, pregnancy, high cardiovascular risk, malignancy.</li> </ul> </li> <li>• CD4 &gt; 500:             <ul style="list-style-type: none"> <li>- Treatment should generally be deferred, independently of plasma HIV RNA; closer follow-up of CD4 if VL &gt; 10<sup>5</sup> c/ml.</li> <li>- Treatment can be offered if presence of ≥ 1 of the above co-morbid conditions (CD4 350-500).</li> </ul> </li> <li>• Whatever CD4 and Plasma HIV RNA, treatment can be offered on an individual basis, especially if patient is seeking and ready for ARV therapy</li> </ul>
<b>RESISTANCE TESTING</b>	<p>Genotypic testing and subtype determination recommended, ideally at the time of HIV diagnosis, otherwise before initiation of first-line regimen</p> <p>If genotypic testing is not available, a ritonavir-boosted PI should be included in the first-line regimen</p>
<b>ADDITIONAL REMARKS</b>	<ul style="list-style-type: none"> <li>• Before starting treatment, CD4 should be repeated and confirmed</li> <li>• Time should be taken to prepare the patient, in order to optimize compliance and adherence**</li> </ul>

\* Pay particular attention to drug-drug interactions, drug toxicities, immune reconstitution syndrome and adherence, etc...

\*\* See recommendation on "Assessing and supporting patients' readiness to start ART"

## Initial Combination Regimen for Antiretroviral-Naïve patient

SELECT 1 DRUG IN COLUMN A AND 1 NRTI COMBINATION IN COLUMN B	A	B	REMARKS
Recommended	<b>NNRTI</b> <ul style="list-style-type: none"> <li>• EFV<sup>1</sup></li> <li>• NVP<sup>5</sup></li> </ul>	TDF/FTC ABC/3TC <sup>2-3-4</sup>	<ul style="list-style-type: none"> <li>- TDF/FTC co-formulated</li> <li>- ABC/3TC co-formulated</li> <li>- EFV/TDF/FTC co-formulated</li> </ul>
	<b>or ritonavir-boosted PI</b> <ul style="list-style-type: none"> <li>• ATV/r<sup>6</sup></li> <li>• DRV/r<sup>6</sup></li> <li>• LPV/r<sup>7</sup></li> <li>• SQV/r</li> </ul>		<ul style="list-style-type: none"> <li>- ATV/r: 300/100 mg qd</li> <li>- DRV/r: 800/100 mg qd</li> <li>- LPV/r: 400/100 mg bid or 800/200 mg qd</li> <li>- SQV/r: 1000/100 mg bid</li> </ul>
Alternative	SQV/r FPV/r RAL <sup>9</sup>	<ul style="list-style-type: none"> <li>• ZDV/3TC<sup>8</sup></li> <li>• ddI/3TC or FTC<sup>8</sup></li> </ul>	<ul style="list-style-type: none"> <li>- SQV/r: 2000/100 mg qd</li> <li>- FPV/r: 700/100 mg bid or 1400/200 mg qd</li> <li>- RAL: 400 mg bid</li> <li>- ZDV/3TC co-formulated</li> </ul>

- 1 EFV: not recommended in pregnant women or women with no reliable and consistent contraception; not active on HIV-2 and HIV-1 group O
- 2 Contra-indicated if HLA B\*5701 positive. Even if HLA B\*5701 negative, counselling on HSR risk still mandatory
- 3 ABC + NVP contra-indicated, unless HLA B\*5701 negative
- 4 Abacavir should be used with caution in patients with a high cardiovascular risk and/or patients with a viral load higher than 100,000 copies/ml.
- 5 NVP: Use with extreme caution in women with CD4 >250 and men with CD4 >400/μL; not active on HIV-2 and HIV-1 group O
- 6 Castle study (LPV/r vs ATV/r) has shown better tolerability of ATV/r and Artemis study (LPV/r vs DRV/r) better efficacy and greater tolerability of DRV/r.
- 7 ACTG 5142, randomised study showed lower virological efficacy of LPV/r vs EFV. However no PI mutations were seen in the LPV/r failures.
- 8 Only if unavailable or intolerant to other recommended NRTIs
- 9 Raltegravir is indicated in combination with other anti-retroviral medicinal products for the treatment HIV-1 infection in adult patients. It has been studied only in combination with TDF/FTC in naïve patients with limited follow-up (48 weeks).

## HAART in TB/HIV co-infection

### Suggested timing of HAART initiation in TB/HIV coinfection according to CD4/ $\mu$ l

CD4 COUNT, CELLS/ $\mu$ l	WHEN TO START HAART
<100	As soon as practical
100–350	As soon as practical, but can wait until after completing 2 months TB treatment especially when there are difficulties with drug interactions, adherence and toxicities
>350	At physician discretion

### Concomitant use of anti-TB medications and antiretrovirals

- NRTIs: no significant interaction with rifampicin nor rifabutin
  - NNRTIs:
    - EFV and rifampicin: EFV 800mg qd if weight >60kg, 600 mg qd if <60kg; rifampicin at standard dose. Some physicians prefer not to dose adapt efavirenz as data are controversial. In any case TDM is recommended after 2 weeks.
    - EFV and rifabutin: EFV at standard dose; rifabutin 450mg daily
    - NVP: not recommended
    - Etravirine: not recommended
  - PIs
    - and rifampicin: not recommended
    - and rifabutin: rifabutin 150 mg x 3 per week with ATV/r, DRV/r, LPV/r or SQV/r; PI/r at standard dose; monitor liver enzyme tests and, whenever possible, perform TDM for PI
  - Raltegravir
    - and rifampicin: use with caution (only if no alternative), if used: raltegravir 800 mg bid
    - and rifabutin: no data
  - Maraviroc
    - and rifampicin: use with caution at double dose 600mg bd maraviroc
    - and rifabutin: standard doses
  - Enfuvirtide: no significant interaction with rifampicin nor rifabutin
- Where combinations are not recommended, specialist HIV treatment advice should be sought. TDM of NNRTI and PI should be performed when drug regimens contain one of these drugs. Drug levels of anti-tuberculosis drugs should be measured when there is clinical concern regarding absorption or response to TB therapy.

### Recommended 1st line ARV combination in patients receiving anti-TB medication

Among recommended regimens for anti-retroviral-naïve patients, preference should be given to EFV/TDF/FTC with dose adaptation of EFV if needed (cf above).

Alternative =

- recommended PI/r + TDF/FTC, using rifabutin instead of rifampicin;
- Use with caution
  1. raltegravir 800 mg bid + TDF/FTC with rifampicin

2. if plasma viral load < 100,000 c/ml, fixed-dose combination of ZDV/ABC/3TC bid +/- tenofovir, could also represent a short term alternative until TB treatment has been completed.

If it is not possible to use these drugs because of resistance/intolerance seek expert help.

## Switch strategies for virologically suppressed patients (confirmed plasma viral load < 50 c/ml)

### Indication:

- Documented toxicity
  - Side-effects
  - Planned pregnancy
  - Wish to simplify regimen
  - Actual regimen no longer recommended
  - Prevention of long-term toxicity (pre-emptive switch)
  - Aging and/or co-morbidity with a possible negative impact of drug(s) in current regimen eg on CVS risk, metabolic parameters.
  - Management of potential drug interactions
  - Management of TB, HBV or HCV infection
5. PI/r or enfuvirtide to raltegravir switch for simplification, prevention or improvement of metabolic abnormalities, adherence facilitation.
  6. Simplification of a complex multi-drug regimen in antiretroviral-experienced patients with 1) substitution of drugs difficult to administer (enfuvirtide) and/or with poor activity (NRTI in case of multiple NRTI resistance) and/or poor tolerability and 2) addition of new well-tolerable, simpler and active agent(s).

### Strategies not recommended:

- a. Intermittent therapy, sequential or prolonged treatment interruptions
- b. 2 drug combination, i.e. 1 NRTI + 1 NNRTI or 1 NRTI + 1 PI without ritonavir or 1 NRTI + RAL, or 2 NRTIs
- c. NRTI-sparing regimen except if documented intolerance to all NRTIs
- d. Triple NRTIs combinations

### Other strategy:

PI/r monotherapy with bid LPV/r, or qd DRV/r, might represent an option in patients with intolerance to NRTI or for treatment simplification. Such strategy only applies to patients without history of failure on prior PI-based therapy and who have had viral load < 50 c/ml in at least the past 6 months.

### Principles:

1. Intra-class switch if drug-specific related adverse event
2. Bid to qd NRTI switch for simplification, prevention of long-term toxicity
3. PI/r to NNRTI switch for simplification, prevention or improvement of metabolic abnormalities, adherence facilitation. NVP has the advantage of its metabolic profile. EFV has the advantage of possible FDC of 3 drugs (Atripla®).
4. Switching from PI/r to NNRTI or raltegravir only possible if 1) no history of prior virological failure; and 2) NRTI backbone fully active.

## Virological Failure

Definition	<p>Confirmed plasma HIV RNA &gt; 50 copies/ml 6 months after starting therapy (initiation or modification) in patients that remain on ART</p>
General measures	<ul style="list-style-type: none"> <li>Evaluate adherence, compliance, tolerability, drug-drug interactions, drug-food interactions, psychosocial issues</li> <li>Perform resistance testing on failing therapy (usually reliable with plasma HIV RNA levels &gt;500-1000 copies/ml) and obtain historical resistance testing for archived mutations</li> <li>Consider TDM</li> <li>Review antiretroviral history</li> <li>Identify treatment options, active, potentially active drugs/combinations</li> </ul>
Management of virological failure (VF)	<p>If plasma HIV RNA &gt; 50 and &lt;500-1000 copies/ml</p> <ul style="list-style-type: none"> <li>Check for adherence</li> <li>Check plasma HIV RNA 1 to 2 months later</li> <li>Improve boosted PI's PK (if applicable)</li> </ul> <p>If plasma HIV RNA confirmed &gt; 500/1000 copies/ml, change regimen as soon as possible: what to change will depend on the resistance testing results:</p> <ul style="list-style-type: none"> <li>No resistance mutations found: re-check for adherence, perform TDM</li> <li>Resistance mutations found: switch to a suppressive regimen based on drug history, multidisciplinary experts discussion advised</li> </ul> <p>Goal of new regimen: plasma HIV RNA &lt; 400 c/ml after 3 months, plasma HIV RNA &lt; 50 c/ml after 6 months</p>
<p><b>In case of resistance mutations demonstrated</b></p>	<p><u>General recommendations:</u></p> <ul style="list-style-type: none"> <li>Use 2 or preferably 3 active drugs in the new regimen (including active drugs from previously used classes)</li> <li>Any regimen should use at least 1 fully active PI/r (e.g. darunavir/r) plus 1 drug from a class not used previously e.g. fusion, integrase or CCR inhibitor (if tropism test shows R5 virus only), or 1 NNRTI (e.g. etravirine), assessed by genotypic testing</li> <li>Defer change if &lt; 2 active drugs available, based on resistance data, except in patients with low CD4 count (&lt;100/mm<sup>3</sup>) or with high risk of clinical deterioration for whom the goal is the preservation of immune function through partial reduction of Plasma HIV RNA (&gt; 1 log reduction) by recycling.</li> <li>If limited options, consider experimental and new mechanistic drugs, favouring clinical trials (but avoid functional monotherapy)</li> <li>Treatment interruption is not recommended</li> </ul> <p><u>Optimisation of new regimen:</u></p> <ul style="list-style-type: none"> <li>If demonstrated NRTI multiple resistance, avoid NRTI but</li> <li>Consider continuation of 3TC or FTC even if documented resistance mutation (M184V/I)</li> <li>Select 1 active ritonavir-boosted PI, if at all possible avoid double boosted PIs</li> <li>Etravirine potentially active in selected NNRTI-mutation profiles</li> <li>Always check for drug-drug-interactions, and when necessary perform TDM of drugs of new regimen if available</li> </ul> <p>If many options are available, criteria of preferred choice include: simplicity of the regimen, toxicity risks evaluation, drug-drug-interactions, future salvage therapy</p>

## Treatment of HIV Pregnant Women

Pregnant women should be monitored every month and as close as possible to the predicted delivery date.

Criteria for starting ART in pregnant women (see different scenarios)	Same as for non pregnant
Objective of treatment in pregnant women	Full Plasma HIV RNA suppression by third trimester and specifically at time of delivery
Resistance testing	Same as for non pregnant, i.e. before starting ART and in case of virological failure
<b>SCENARIO</b> <ol style="list-style-type: none"> <li>1 Women becoming pregnant while already on ART</li> <li>2 Women becoming pregnant while treatment naïve and who fulfil the criteria (CD4) for initiation of ART</li> <li>3 Women becoming pregnant while treatment naïve and who do not fulfil the criteria (CD4) for initiation of ART</li> <li>4 Women whose follow up starts after W28 of pregnancy</li> </ol>	<ol style="list-style-type: none"> <li>1 Maintain ART but switch drugs that are potentially teratogenic</li> <li>2 Start ART at start of 2nd trimester is optimal</li> <li>3 Start ART at start of W28 of pregnancy (at the latest 12 weeks before delivery); start earlier if high plasma viral load or risk of prematurity</li> <li>4 Start ART immediately</li> </ol>
Antiretroviral regimen in pregnancy	Same as non pregnant, <ul style="list-style-type: none"> <li>• except avoid EFV</li> <li>• NVP not to be initiated but continuation is possible if started before pregnancy</li> <li>• Among PI/r, prefer LPV/r or SQV/r or ATV/r</li> <li>• RAL, DRV/r: few data available in pregnant women</li> <li>• ZDV should be part of the regimen if possible</li> </ul>
Drugs contra-indicated during pregnancy	Efavirenz, ddI + d4T, Triple NRTI combinations
IV zidovudine during labour	Benefit uncertain if Plasma HIV RNA < 50 c/ml
Single dose nevirapine during labour	Not recommended
Caesarean section	Benefit uncertain if Plasma HIV RNA < 50 c/ml at W34-36

## Post-Exposure Prophylaxis

	POST-EXPOSURE PROPHYLAXIS (PEP) RECOMMENDED IF	
	Nature of exposure	Status of source patient
Blood	Subcutaneous or intramuscular penetration with IV or IM needle, or intravascular device	HIV + Or serostatus unknown but presence of HIV risk factors
	<ul style="list-style-type: none"> <li>• Percutaneous injury with sharp instrument (lancet), IM or SC needle, suture needle</li> <li>• Contact &gt; 15 min of mucous membrane or non intact skin</li> </ul>	HIV +
Genital secretions	Anal or vaginal sex	HIV + Or serostatus unknown but presence of HIV risk factors
	Receptive oral sex with ejaculation	HIV +
Intravenous drug user	Exchange of syringe, needle, preparation material or any other material	HIV +

- Rapid testing of the source patient for HCV and HIV (if HIV status unknown) recommended,
- If source patient HIV+ on ARV therapy, order genotyping testing if HIVRNA > 1000 copies/μL
- If prior resistance test available in source patient, individualize the PEP therapy accordingly
- PEP to be started ideally < 4 hours after the exposure, and no later than 48 hours
- Duration of PEP: 4 weeks
- Standard PEP regimen: TDF/FTC (alternative: ZDV/3TC) + LPV/r tablets 400/100 mg bid
- Full sexual health screen in case of sexual exposure
- Follow-up:
  - HIV serology + HBV and HCV, pregnancy test
  - (women) within 48 hours of exposure
  - Reevaluation of PEP indication by HIV expert within 48-72 hours
  - Assess tolerability of ARV PEP regimen
  - Transaminases, HCV-PCR and HCV serology at month 1 if source of exposure were HCV+ (observed or suspected)
  - Repeat HIV serology after 2 and 4 months, syphilis serology after 1 month if sexual exposure

European AIDS Clinical Society

**Guidelines**  
Prevention and Management  
of Non-Infectious  
Co-Morbidities in HIV



## Index

• Panel members . . . . .	28
• Abbreviations used throughout this document . . . . .	29
• HIV specific issues to be considered in managing “non-infectious” co-morbidities . . . . .	30
• Screening for non-infectious co-morbidities . . . . .	32
• Cancer - screening methods . . . . .	35
• Antiretroviral drugs & drug classes: frequent/severe side effects. . . . .	36
• Life style interventions . . . . .	40
• Prevention of CVD. . . . .	42
• Hypertension: diagnosis and management . . . . .	44
• Type 2 diabetes: diagnosis and management. . . . .	47
• Dyslipidaemia: management . . . . .	49
• Bone disease: diagnosis, prevention and management . . . . .	50
• Depression: diagnosis and management . . . . .	54
• Hyperlactataemia: diagnosis, prevention and management . . . . .	56
• Kidney disease: diagnosis, prevention and management . . . . .	57
• Lipodystrophy: prevention and management. . . . .	59
• Work-up and Management of the HIV patient with increased ALT/AST . . . . .	60
• Neurocognitive impairment: diagnosis and management. . . . .	62

### Online:

- Indications and tests for proximal renal tubulopathy (PRT)
- Dose adjustment of antiretrovirals for impaired renal function
- International HIV Dementia Scale (IHDS)
- CNS penetration of antiretroviral drugs
- Classification, doses, safety and side effects of antidepressants
- Interactions between antidepressants and antiretroviral agents
- List of selected dermal/soft tissue fillers used for restorative treatment

## Panel Members

Jens D. Lundgren,  
Copenhagen, *Denmark*  
Chair

Manuel Battegay,  
Basel, *Switzerland*

Georg Behrens,  
Hannover, *Germany*

Simon Collins,  
London, *United Kingdom*

Juliet Compston,  
Cambridge, *United Kingdom*

Gilbert Deray,  
Paris, *France*

Stephane De Wit,  
Brussels, *Belgium*

Christoph A. Fux,  
Bern, *Switzerland*

Giovanni Guaraldi,  
Modena, *Italy*

Patrick Mallon,  
Dublin, *Ireland*

Esteban Martinez,  
Barcelona, *Spain*

Socrates Papapoulos,  
Leiden, *The Netherlands*

Neil Poulter,  
London, *United Kingdom*

Peter Reiss,  
Amsterdam, *The Netherlands*

Jussi Sutinen,  
Helsinki, *Finland*

Alessandra Vigano,  
Milan, *Italy*

Ian Williams,  
London, *United Kingdom*

and the EACS Executive Committee

## Abbreviations used throughout this document

- ABC=abacavir;
  - ACE=angiotensin converting enzyme;
  - ALP=alkaline phosphatase;
  - ALT=alanine aminotransferase;
  - aMDRD=abbreviated Modification of Diet in Renal Disease formula;
  - ART=antiretroviral therapy;
  - AST=aspartate aminotransferase;
  - ATV=atazanavir;
  - BMD=bone mineral density;
  - CKD=chronic kidney disease;
  - CNS=central nervous system;
  - COPD=chronic obstructive pulmonary disease
  - CSF=cerebrospinal fluid;
  - CVD=cardiovascular disease;
  - d4T=stavudine;
  - DXA=dual energy X-ray absorptiometry;
  - ddl=didanosine;
  - DRV=darunavir;
  - EFV=efavirenz;
  - eGFR=estimated glomerular filtration rate;
  - ENF=enfuvirtide;
  - ETV=etravirine;
  - FPV=fos-amprenavir;
  - FRAX=Fracture Risk Assessment Tool;
  - FTC=emtricitabine;
  - HBV=hepatitis B virus;
  - HCV=hepatitis C virus;
  - HDL-c=HDL-cholesterol;
  - HIVAN=HIV associated nephropathy;
  - IDV=indinavir;
  - IHD=ischaemic heart disease;
  - LDL-c=LDL-cholesterol;
  - LPV=lopinavir;
  - MVC=maraviroc;
  - NfV=nelfinavir;
  - NNRTI=non-nucleoside reverse transcriptase inhibitors;
  - NRTI=nucleos(t)ide reverse transcriptase inhibitors;
  - NVP=nevirapine;
  - PI=protease inhibitors;
  - PI/r=protease inhibitors pharmacologically boosted with ritonavir;
  - PSA=prostate specific antigen;
  - PTH=parathyroid hormone;
  - RAL=raltegravir;
  - RTV=ritonavir (used as booster= /r);
  - SQV=saquinavir;
  - 3TC=lamivudine;
  - TC=total cholesterol;
  - TG=triglycerides;
  - TDF=tenofovir;
  - TPV=tipranavir;
  - UAC/ : urine albumin/creatinine ratio;
  - UP/C: : urine protein/creatinine ratio;
  - ZDV=zidovudine
- Acknowledgements: The guidelines panel has received helpful comments and suggestions from the following persons: EACS executive committee, T Brown, A Carr, U Gschwandtner, E Negrodo, P Portegies, SW Worm.

## HIV specific issues to be considered in managing “non-infectious” co-morbidities

Non-infectious co-morbidities include cardiovascular, renal, hepatic, metabolic, neoplastic, bone pathologies and depression. Although HIV and other infections may be involved in their pathogenesis, these guidelines focus on preventive and/or management principles other than use of antivirals and other anti-infectious agents in adults and adolescent HIV-infected persons.

These co-morbidities are becoming increasingly important for HIV-infected persons as a consequence of increased life expectancy resulting from effective ART. Additionally, several demonstrated and proposed HIV-associated risk factors may contribute to their development including immune activation, inflammation and coagulation associated with (uncontrolled) replication of HIV, co-infections (e.g. HCV), ART itself and persistent immunodeficiency.

Health care professionals involved with the care of HIV-infected persons who are not familiar with the use of ART should consult HIV specialists before introducing or modifying any type of treatment that HIV-infected patients receive.

Conversely, many HIV physicians are not specialists in non-infectious co-morbidities, and should seek expert advice where appropriate in the prevention and management of such conditions. Situations where consultation is generally recommended are indicated in these guidelines.

Preventing or managing these diseases in HIV often involves polypharmacy, which increases the risk of suboptimal adherence and hence may compromise the continued benefit of ART. Additionally, the possibility of drug-drug interactions with ART should be carefully considered prior to introducing any treatment. Several websites exist for this purpose: [www.HIV-druginteractions.org](http://www.HIV-druginteractions.org), [www.HIVpharmacology.com](http://www.HIVpharmacology.com), [www.AIDSinfo.nih.gov](http://www.AIDSinfo.nih.gov).

These guidelines are intended to provide the best guide to clinical management, and it is recognised that the level of evidence to support the advice varies. Indeed, there is limited evidence from randomised controlled trials on best management of non-infectious co-morbidities in HIV. As a result current management is mainly derived from general medical guidelines. These guidelines therefore represent the collective consensus opinion of a panel of experts in the field of HIV and the respective range of co-morbidities, and no attempt to rate the underlying evidence and strength of the panel's recommendations was undertaken.

Dependent on future clinical research findings, these guidelines will be regularly updated as required. The online version of guidelines, at [www.europeanaidsclinicalociety.org](http://www.europeanaidsclinicalociety.org), contains more detailed information, links to other relevant websites and will be regularly updated.

The current guidelines highlight non-infectious co-morbidities that are seen frequently in the routine care of HIV-infected persons and those for which specific issues should be considered. Other related conditions in the management of HIV disease that are not extensively discussed, but may be included in future versions are:

- Sexual dysfunction. This is frequently encountered and often requires a multi-disciplinary approach for its management that may include both expert psychological counselling and medical interventions.
- Hypogonadism,
- Other women's health issues, and
- Neuropathy which may be caused by infections (e.g. HIV), some ARV ([see p. 37](#)), other neuropathic drugs, and by metabolic diseases (eg. diabetes).

## Screening for non-infectious co-morbidities

	Assessment	At HIV diagnosis	Prior to starting cART	Follow up frequency		Comment	See page
				with cART	without cART		
History	<ul style="list-style-type: none"> <li>Past and current co-morbidities</li> <li>Family history (eg premature CVD, diabetes, hypertension, CKD)</li> <li>Concomitant medications<sup>i</sup></li> <li>Current lifestyle (alcohol use, smoking, diet, aerobic exercise)</li> </ul>	+	+	every visit 6-12 m	every visit annual	On transfer of care repeat assessment Premature CVD: Cardiovascular events in a first degree relative: male <55, female <65 years  Adverse lifestyle habits should be addressed more frequently	<a href="#">42</a>
		+	+				<a href="#">40</a>
Body composition	<ul style="list-style-type: none"> <li>Body-mass index</li> <li>Clinical lipodystrophy assessment</li> </ul>	+	+	annual annual	annual		<a href="#">59</a>
Cardiovascular disease	<ul style="list-style-type: none"> <li>Risk assessment (Framingham score<sup>ii</sup>)</li> <li>ECG</li> </ul>	+	+	annual	annual	Should be performed in every older patient without CVD (Men > 40 years; Women >50 years)	<a href="#">42</a>
Hypertension	<ul style="list-style-type: none"> <li>Blood pressure</li> </ul>	+	+	annual	annual		<a href="#">44</a>
Dyslipidaemia	<ul style="list-style-type: none"> <li>TC, HDL-c, LDL-c, TG<sup>iii</sup></li> </ul>	+	+	annual		Repeat in fasting state if used for medical intervention (i.e. ≥8h without caloric intake)	<a href="#">49</a>
Diabetes mellitus	<ul style="list-style-type: none"> <li>Serum glucose</li> </ul>	+	+	6-12 m		Consider oral glucose tolerance test if repeated fasting glucose levels of 6.1-6.9 mmol/L (110-125 mg/dL)	<a href="#">47</a>
Liver disease	<ul style="list-style-type: none"> <li>Risk assessment<sup>iv</sup></li> <li>ALT/AST, ALP</li> </ul>	+	+	annual 3-6 m	annual 6-12 m	More frequent monitoring prior to starting and on treatment with hepatotoxic drugs	<a href="#">60</a>
Renal disease	<ul style="list-style-type: none"> <li>Risk assessment<sup>v</sup></li> <li>eGFR (aMDRD)<sup>vi</sup></li> <li>Urine Dipstick analysis<sup>vii</sup></li> </ul>	+	+	annual 3-6 m	annual 6-12 m	More frequent monitoring if CKD risk factors present and/or prior to starting and on treatment with nephrotoxic drugs <sup>viii</sup> Every 6 months if eGFR <60 ml/min; If proteinuria ≥1+ and/or eGFR<60 ml/min perform UP/C or UAC <sup>vii</sup>	<a href="#">57</a>
Bone disease	<ul style="list-style-type: none"> <li>Risk assessment<sup>ix</sup></li> <li>FRAX®<sup>x</sup> in patients &gt;40 years)</li> <li>25-OH vitamin D</li> </ul>	+	+	2 yrs	2 yrs	If not using FRAX®, consider DXA of spine and hip in specific patients Repeat according to risk factors	<a href="#">50</a>
Neurocognitive impairment	<ul style="list-style-type: none"> <li>Questionnaire</li> </ul>	+	+	1-2 yrs	1-2 yrs	Screen risk patients	<a href="#">62</a>
Depression	<ul style="list-style-type: none"> <li>Questionnaire</li> </ul>	+	+	1-2 yrs	1-2 yrs	Screen risk patients	<a href="#">54</a>
Cancer	<ul style="list-style-type: none"> <li>Mammography</li> <li>Cervical PAP</li> <li>Others</li> </ul>			1-3 yrs 1-3 yrs	1-3 yrs 1-3 yrs	Women 50-70 years Sexually active women, frequency depending on CD4 Controversial	<a href="#">35</a>

## Notes

### Screening for non-infectious co-morbidities

- i Review all concomitant medications that increase the risk of co-morbidities: eg diabetes: neuroleptic drugs including clozapine, olanzapine; pentamidine, glucocorticoids, IFN- $\alpha$ , thiazide diuretics, furosemide, phenytoin, diazoxide, beta-blockers and others; renal disease: NSAIDs
- ii A risk equation developed from HIV populations is under development (see: [www.cphiv.dk/tools.aspx](http://www.cphiv.dk/tools.aspx)). Of note, if individual patients receive medication to control dyslipidaemia and/or hypertension, any risk estimation should be interpreted with caution.
- iii Calculator for LDL-cholesterol in cases where TG is not high can be found at [www.cphiv.dk/tools.aspx](http://www.cphiv.dk/tools.aspx).
- iv Risk factors for chronic liver disease include: alcohol, viral hepatitis, obesity, diabetes, insulin resistance, hyperlipidaemia, hepatotoxic drugs
- v Risk factors for chronic kidney disease (CKD): hypertension, diabetes, CVD, family history, black African ethnicity, viral hepatitis, concomitant nephrotoxic drugs.
- vi eGFR: use aMDRD based on serum creatinine, gender, age and ethnicity (see: [www.cphiv.dk/tools.aspx](http://www.cphiv.dk/tools.aspx)).
- vii Some experts recommend UA/C or UP/C as screening test for proteinuria in all patients. UA/C: urinary albumin creatine ratio (mg/mmol) predominantly detects glomerular disease. Use in patients with diabetes mellitus. UP/C: urinary total protein creatinine ratio (mg/mmol) detects total protein secondary to glomerular and tubular disease
- viii Additional screening is required for patients receiving tenofovir ([see p. 58](#))
- ix Classic risk factors: older age, female gender, hypogonadism, family history of hip fracture, low BMI ( $\leq 19$  kg/m<sup>2</sup>), vitamin D deficiency, smoking, physical inactivity, history of low impact fracture, alcohol excess (>3 units/day), steroid exposure (minimum prednisone 5mg or equivalent for >3 months)
- x See: [www.shef.ac.uk/FRAX](http://www.shef.ac.uk/FRAX)

### Cancer - screening methods<sup>1</sup>

Problem	Patients	Procedure	Evidence of benefit	Screening interval	Additional comments
Breast cancer	Women 50-70 yrs	Mammography	↓ breast cancer mortality	1-3 years	
Cervical cancer	Sexually active women	Papnicolau test	↓ cervical cancer mortality	1-3 years	Target age group should include at least the age range 30 to 59 years. Longer screening interval if prior screening tests repeatedly negative
Anal cancer	Homosexual men	Digital rectal exam ± Papanicolau test	Unknown - advocated by some experts	1-3 years	If Pap test abnormal, anoscopy
Colorectal cancer	Persons 50-75 yrs	Fecal Occult Blood test	↓ colorectal cancer mortality	1-3 years	Benefit is marginal
Prostate cancer	Men >50 yrs	Digital rectal exam ± Prostate specific antigen (PSA)	Controversial	1-3 years	Pros: ↑ early diagnosis Cons: Overtreatment, no ↓ cancer-related mortality

- i Screening recommendations derived from the general population. These screenings should preferably be done as part of national general population-screening programs. Although non-Hodgkin lymphoma has a higher incidence in HIV-infected patients than in the general population, it is currently unknown whether it can be screened. Careful examination of skin should be performed regularly to detect cancers such as Kaposi's sarcoma, basal cell carcinoma and malignant melanoma.

Antiretroviral drugs & drug classes: **frequent/severe side effects<sup>i</sup> - 1/2**

	Skin	Digestive	Liver	CV	Musculo-skeletal	Genitourinary	Nervous	Body fat	Metabolic	Other
<b>NRTI</b>										
ZDV	Nail pigmentation	Nausea	Steatosis		Myopathy			<b>Lipoatrophy</b>	Dyslipidaemia, Hyperlactataemia	<b>Anemia</b>
d4T		<b>Pancreatitis</b>	<b>Steatosis</b>				<b>Peripheral neuropathy</b>	<b>Lipoatrophy</b>	<b>Dyslipidaemia</b> Hyperlactataemia	
ddI		<b>Pancreatitis</b>	Steatosis, Liver fibrosis	<b>IHD</b>			<b>Peripheral neuropathy</b>		Hyperlactataemia	
3TC										
FTC										
ABC	<b>Rash*</b>			<b>IHD</b>						<b>*: Systemic Hypersensitivity (HLA B*5701 dependent)</b>
TDF					↓ BMD, Osteomalacia	↓ GFR, <b>Fanconi syndrome</b>				
<b>NNRTI</b>										
EFV	Rash		Hepatitis				Depression, Suicidal ideation, <b>Dizziness, Sleep disturbances</b>		<b>Dyslipidaemia</b> Gynaecomastia	Teratogenesis
NVP	<b>Rash</b>		<b>Hepatitis</b>							<b>Systemic Hypersensitivity (CD4- and gender-dependent)</b>
ETV	<b>Rash</b>									

Antiretroviral drugs & drug classes: **frequent/severe** side effects<sup>i</sup> - 2/2

	Skin	Digestive	Liver	CV	Musculo-skeletal	Genitourinary	Nervous	Body fat	Metabolic	Other	
<b>PI</b>											
IDV	<b>Dry skin</b> Nail dystrophy	Nausea and diarrhoea <sup>ii</sup>	Jaundice	<b>IHD</b>		<b>Nephrolithiasis</b>		<b>↑abdominal fat</b>	<b>Dyslipidaemia</b> Diabetes mellitus		
SQV									Dyslipidaemia		
LPV					<b>IHD</b>				<b>Dyslipidaemia</b>		
FPV	Rash				<b>IHD</b>				<b>Dyslipidaemia</b>		
ATV				Jaundice			Nephrolithiasis			Dyslipidaemia	
DRV										Dyslipidaemia	
TPV				<b>Hepatitis</b>				<b>Intracranial haemorrhage</b>		<b>Dyslipidaemia</b>	
<b>Fusion inhibitors</b>											
ENF	<b>Injection site reactions</b>									Hypersensitivity, ↑risk for pneumonia	
<b>Integrase inhibitors</b>											
RAL		Nausea			Myopathy		Headache				
<b>CCR5 inhibitors</b>											
MVC			Hepatitis	<b>IHD</b>						↑risk for infections	

i “Severe events” (events that can put patient’s life at risk and represent a medical emergency) are marked in bold letters. “Frequent events” (events expected in at least 10% of treated patients) are marked in red. Background knowledge on tolerability of ENF, DRV, ETV, RAL, and MVC is limited because of its recent introduction into the clinical armamentarium.

ii Frequency and severity differs between individual agents.

## Life style interventions<sup>i</sup>

INTERVENTION	PRINCIPLES
<p><b>Smoking cessation</b></p>	<ul style="list-style-type: none"> <li>- Brief unambiguous statement about need to stop smoking</li> <li>- If patient is not contemplating, try to motivate and emphasize positive short-term aspects (more money for better things, better taste for food, better skin, less dyspnoea), and long-term benefits (prevention of COPD, IHD, stroke, lung cancer)</li> <li>- If patient is contemplating, try to fix stop date, establish reward system</li> <li>- Use nicotine substitution (patch, chewing gum, spray), varenicline, or bupropion (note: both drugs may cause central nervous system side effects including suicide; bupropion may interact with PI and NNRTI) during weaning phase if necessary</li> <li>- Consider referring patient to specialized stop smoking clinics</li> <li>- Anticipate relapses, explain and consider them as part of the weaning process to final nicotine abstinence</li> </ul>
<p><b>Dietary counselling</b></p>	<ul style="list-style-type: none"> <li>- Dietary intervention should not interfere with the dietary requirements required for appropriate absorption of ART drugs</li> <li>- Keep caloric intake balanced with energy expenditure</li> <li>- Limit intake of saturated fat, cholesterol and refined carbohydrates</li> <li>- Reduce total fat intake to &lt; 30% and dietary cholesterol to &lt;300mg/day</li> <li>- Emphasize intake of vegetables, fruits, grain products with fibre</li> <li>- Emphasize consumption of fish, poultry (without skin) and lean meat</li> <li>- Consider referral to dietician, one week food and drink diary to discover 'hidden' calories</li> <li>- Avoid binge eating ('yo-yo dieting')</li> <li>- In patients with HIV-related wasting and dyslipidaemia address wasting first and consider referral to dietician</li> </ul>
<p><b>Exercise promotion</b></p>	<ul style="list-style-type: none"> <li>- Patients who are obviously overweight should be motivated to lose weight. Starvation diets are not recommended (immune defence mechanisms potentially decreased). Malnutrition has to be addressed where observed. Normal BMI range: 18.5-24.9; Overweight: 25.0-29.9, Obesity: &gt; 30.0 kg/m<sup>2</sup></li> <li>- Intake of alcohol should be restricted to &lt;20-40g/d</li> </ul>
	<ul style="list-style-type: none"> <li>- Promote active lifestyle to prevent and treat obesity, hypertension and diabetes</li> <li>- Encourage self-directed moderate level physical activity (take the stairs, cycle or walk to work, cycling, swimming, hiking etc.)</li> <li>- Emphasize regular moderate-intensity exercise rather than vigorous exercise</li> <li>- Achieve cardiovascular fitness (e.g. 30 minutes brisk walking →5 days a week)</li> <li>- Maintain muscular strength and joint flexibility</li> </ul>

<sup>i</sup> Based on recommendations by the US Preventive Services Task Force.

## Prevention of CVD

Principles: The intensity of efforts to prevent CVD depends on the underlying risk of CVD, which can be estimated. The preventive efforts are diverse in nature and require involvement of a relevant specialists, in particular if the risk of CVD is high and always in patients with a history of CVD.

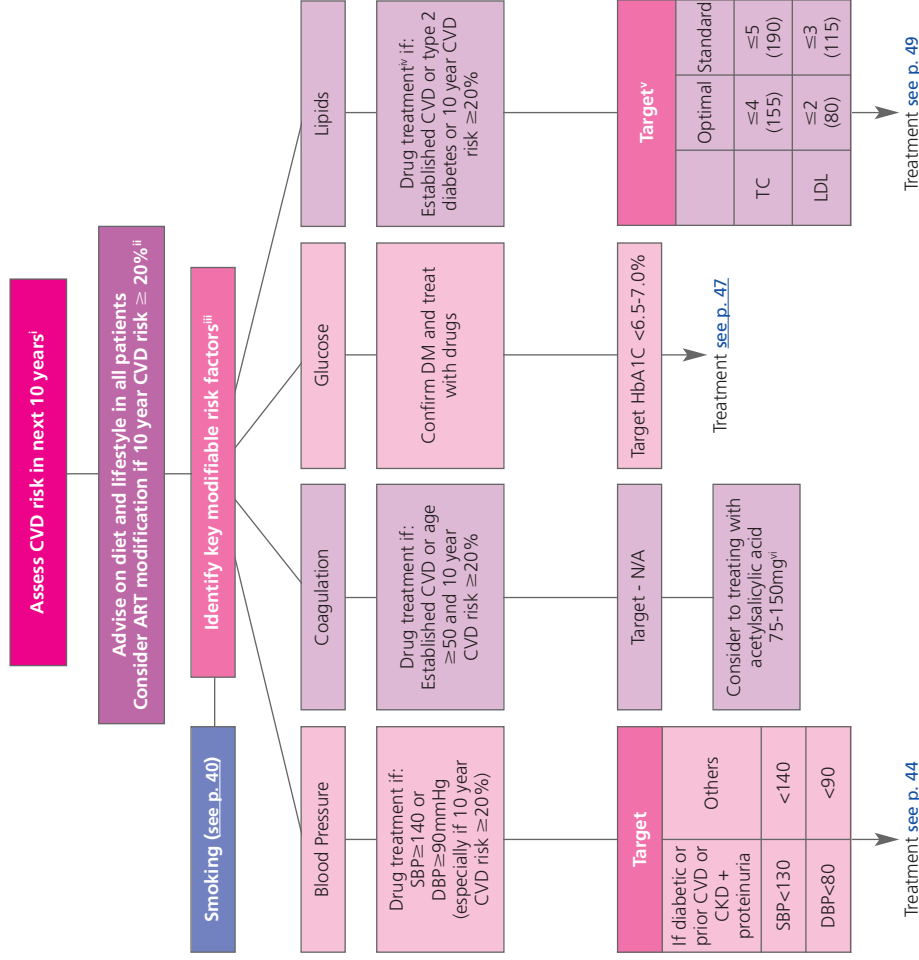

- i Use the Framingham equation; a risk equation developed from HIV populations is under development (see: [www.cphiv.dk/tools.aspx](http://www.cphiv.dk/tools.aspx)). This assessment and the associated considerations outlined in this figure should be repeated annually in all patients under care (see p. 32) to ensure that the various interventions are initiated in a timely way.
- ii Options for ART modification include: (1) replace PVR with NNRTI or by another PVR known to cause less metabolic disturbances (see p. 36); (2) consider replacing d4T, ZDV or ABC with TDF.
- iii Of the modifiable risk factors outlined, drug treatment is reserved for certain subgroups where benefits are considered to outweigh potential harm. Of note, there is a combined benefit of various interventions in target groups identified. Per 10 mmHg reduction in systolic blood pressure, per 1 mmol/L (39 mg/dL) reduction in TC and with use of acetylsalicylic acid, each reduces risk of IHD by 20-25%, the effect is additive. Observational studies suggest that smoking cessation results in greatest reductions in risk of IHD 50% - and this is additive to other interventions. This benefit only becomes apparent up to 5 years from when intervention was first applied.
- iv See discussion on drug treatment of patients with lower CVD risk at [www.nhlbi.nih.gov/guidelines/cholesterol/atp3\\_rpt.htm](http://www.nhlbi.nih.gov/guidelines/cholesterol/atp3_rpt.htm).
- v Target levels are to be used as guidance and are not definitive – expressed as mmol/L with mg/dL in parenthesis. In case LDL cannot be calculated because of high triglyceride levels, the non-HDL-c (TC minus HDL-c) target should be used which is 0.8 mmol/L (30 mg/dL) higher than the corresponding LDL-c target. Target levels for TG are not listed because an independent contribution from TG to CVD risk is uncertain and hence whether this condition should be treated (see p. 49).
- vi Evidence for benefit when used in persons without a history of CVD (including diabetics) is less compelling.

## Hypertension: diagnosis and management - 1/2

		BLOOD PRESSURE (mmHG) <sup>i</sup> - LEVELS			+ DIAGNOSIS & GRADING OF HYPERTENSION	
Other risk factors and disease history	Normal: SBP 120-129 or DBP 80-84	High normal: SBP 130-139 or DBP 85-89	Grade 1: SBP140-159 or DBP 90-99	Grade 2: SBP 160-179 or DBP100-109	Grade 3: SBP > 180 or DBP > 110	
No other risk factors	Average risk	Average risk	Low added risk	Moderate added risk	High added risk	
	No BP intervention	No BP intervention	Lifestyle changes for several months <sup>ii</sup> , then possible drug therapy <sup>iii</sup>	Lifestyle changes for several months <sup>ii</sup> , then drug therapy <sup>iii</sup>	Immediate drug therapy <sup>iii</sup> and lifestyle changes <sup>i</sup>	
1-2 risk factors <sup>iv</sup>	Low added risk	Low added risk	Moderate added risk	Moderate added risk	Very high added risk	
	Lifestyle changes <sup>i</sup>	Lifestyle changes <sup>ii</sup>	Lifestyle changes for several months <sup>ii</sup> , then drug therapy <sup>iii</sup>	Lifestyle changes for several months <sup>ii</sup> , then drug therapy <sup>iii</sup>	Immediate drug therapy <sup>iii</sup> and lifestyle changes <sup>i</sup>	
3 or more risk factors <sup>iv</sup> or target organ disease <sup>v</sup> or diabetes	Moderate added risk	High added risk	High added risk	High added risk	Very high added risk	
	Lifestyle changes <sup>i</sup>	Drug therapy <sup>iii</sup> and lifestyle changes <sup>i</sup>	Drug therapy <sup>iii</sup> and lifestyle changes <sup>i</sup>	Drug therapy <sup>iii</sup> and lifestyle changes <sup>i</sup>	Immediate drug therapy <sup>iii</sup> and lifestyle changes <sup>i</sup>	
Associated clinical conditions <sup>vi</sup>	High added risk	Very high added risk	Very high added risk	Very high added risk	Very high added risk	
	Drug therapy <sup>iii</sup> and lifestyle changes <sup>i</sup>	Immediate drug therapy <sup>iii</sup> and lifestyle changes <sup>i</sup>	Immediate drug therapy <sup>iii</sup> and lifestyle changes <sup>i</sup>	Immediate drug therapy <sup>iii</sup> and lifestyle changes <sup>i</sup>	Immediate drug therapy <sup>iii</sup> and lifestyle changes <sup>i</sup>	

- i SBP =systolic blood pressure; DBP = diastolic blood pressure. Repeated blood pressure measurements should be used for stratification
- ii Recommended life style interventions - [see p. 40](#). Table adapted from J. Hypertension 2003; 21:1779-86.
- iii [See next page](#)
- iv Risk factors include age (>45 years for men; > 55 years for women), smoking, family history of premature CVD

- v Target organ disease: left ventricular hypertrophy, ultrasound evidence of arterial wall thickening, microalbuminuria.
- vi Associated clinical conditions: CVD, IHD, renal disease, peripheral vascular disease, advanced retinopathy.

Warning: Caution regarding drug-drug interactions with antihypertensive drugs and ART.

## Hypertension: diagnosis and management - 2/2

### Choosing drugs<sup>i</sup> for patients newly diagnosed with hypertension

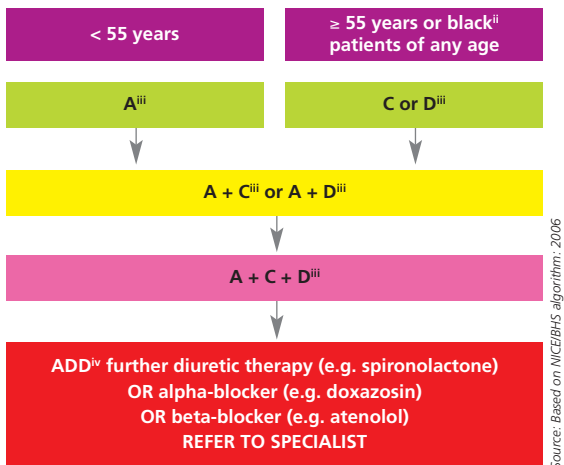

#### Abbreviations + details:

- A = ACE inhibitor (e.g. perindopril, lisinopril, ramipril)  
(consider angiotensin-II receptor antagonist (e.g. losartan, candesartan) if ACE intolerant)
- C = Dihydropyridine calcium-channel blocker (e.g. amlodipine). If not tolerated, verapamil (note: dose with caution with PIs which may increase plasma concentrations leading to toxic reactions), or diltiazem may be used.
- D = thiazide-type diuretic

- i Several anti-hypertensive drugs interact with the pharmacokinetics of ART – check always for drug-drug interactions
- ii Black patients are those of African or Caribbean descent, and not mixed-race, Asian or Chinese patients
- iii Await 2-6 weeks to assess whether target (p. 42) is achieved – if not go to next step.
- iv Requirement of 4-5 drugs to manage hypertension requires specialist training

## Type 2 diabetes: diagnosis and management

### Diagnostic criteria<sup>i</sup>

	Fasting plasma glucose mmol/L (mg/dl) <sup>ii</sup>	Oral glucose tolerance test (OGTT) 2-h value mmol/L (mg/dl) <sup>iii</sup>
<b>Diabetes</b>	≥ 7.0 (126) OR →	≥ 11.1 (200)
<b>Impaired glucose tolerance (IGT)</b>	< 7.0 (126) AND →	7.8 – 11.0 (140 – 199)
<b>Impaired fasting glucose (IFG)</b>	6.1 – 6.9 (110 – 125) AND →	< 7.8 (140)

- i As defined by WHO and International Diabetes Federation (2005)
  - ii An abnormal finding should be repeated before confirming the diagnosis.
  - iii Is recommended in patients with fasting blood glucose 6.1 – 6.9 mmol/L (110 – 125 mg/dL) as it may identify patients with overt diabetes.
- Both IGT and IFG increase CV morbidity and mortality, and increase the risk of developing diabetes by 4-6 fold. These patients should be targeted for life style intervention, and their CV risk factors must be evaluated and treated.

### Interventions for treatment of diabetes

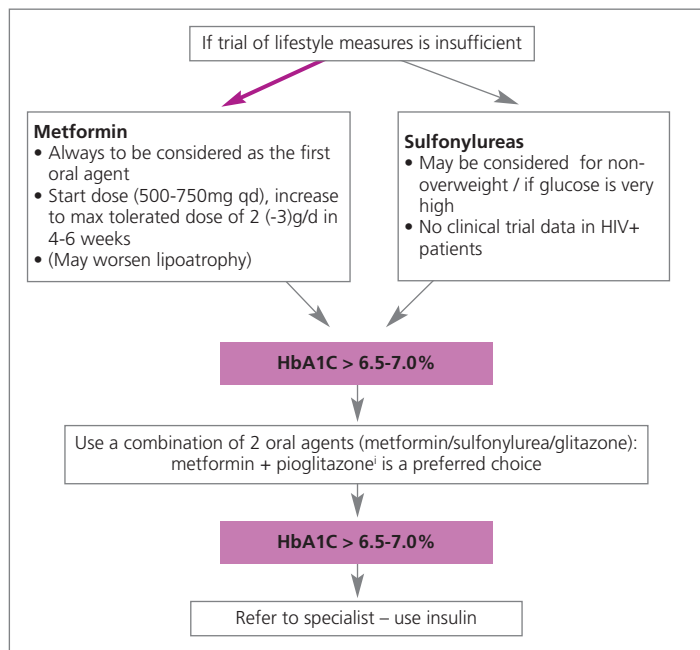

i some experts consider pioglitazone as first-line monotherapy for a lipotrophic diabetic patient

### Management of patients with diabetes

Treatment goals: glucose control (HbA1c < 6.5-7.0% without hypoglycaemia, fasting plasma glucose 4-6 mmol/l (73-110 mg/dl)); Normal blood lipids and blood pressure < 130/80 mmHg (see p. 49 and p. 44). Acetylsalicylic acid (75-150mg/d) considered in diabetics with elevated underlying CVD risk (see p. 42). Nephropathy, polyneuropathy and retinopathy screening should be performed as in diabetic patients without HIV. Consultation with a specialist in diabetology is recommended.

### Dyslipidaemia: management

Principles: Higher LDL-c levels increase risk of CVD and reduction thereof reduces this risk; the reverse is true for HDL-c. Conversely, the CVD risk implications from higher than normal TG levels are less clear, as is the clinical benefit of treating moderate hypertriglyceridaemia; very high TG (>10 mmol/L or > 90mg/dL) may increase risk of pancreatitis, although direct evidence is lacking. Diet, exercise, maintaining normal body weight and stopping smoking tends to improve dyslipidaemia; if not effective, consider change of ART and then consider lipid-lowering medication in high-risk patients (see p. 42).

#### Drugs used to lower LDL-c

Drug class	Drug	Dose	Side effects	ADVISE ON USE OF STATIN TOGETHER WITH ART	
				Use with PI/r	Use with NNRTI
Statin <sup>i</sup>	Atorvastatin <sup>ii</sup>	10-80 mg QD	Gastrointestinal symptoms, headache, insomnia, rhabdomyolysis (rare) and toxic hepatitis	Start with low dose <sup>v</sup> (max: 40 mg)	Consider higher dose <sup>vi</sup>
	Fluvastatin <sup>iii</sup>	20-80 mg QD		Consider higher dose <sup>vi</sup>	Consider higher dose <sup>vi</sup>
	Pravastatin <sup>iii</sup>	20-80 mg QD		Consider higher dose <sup>vi,vi</sup>	Consider higher dose <sup>vi</sup>
	Rosuvastatin <sup>ii</sup>	5-40 mg QD		Start with low dose <sup>v</sup> (max: 20 mg)	Start with low dose <sup>v</sup>
	Simvastatin <sup>ii</sup>	10-80 mg QD		<b>Contraindicated</b>	Consider higher dose <sup>vi</sup>
Cholesterol uptake <sup>j</sup>	Ezetimibe <sup>v</sup>	10 mg QD	Gastrointestinal symptoms	No known drug-drug interactions with ART	

i A statin is preferred first-line therapy; different statins have variable intrinsic LDL-c lowering ability<sup>ii,iii,iv</sup>. Target levels for LDL-c see p. 42. In persons where LDL-c targets are difficult to achieve, consult/refer to specialist.  
 ii, iii, iv Expected range of reductions of LDL-c: <sup>ii</sup>1.5-2.5 mmol/L (60-100) mmol/L, <sup>iii</sup>0.8-1.5 mmol/L (35-60 mg/dl), <sup>iv</sup>0.2-0.5 mmol/L (10-20 mg/dl)  
 v, vi The ART drug may inhibit (statin toxicity, ↓ dose) or <sup>vi</sup>induce (≈less effect of statin, ↑ dose gradually to achieve expected benefit<sup>ii,iii</sup>) the excretion of the statin.  
 vii **Exception:** If used with **DRV/r**, start with lower dose of **pravastatin**.

## Bone disease: diagnosis, prevention and management

CONDITION	CHARACTERISTICS	RISK FACTORS	DIAGNOSTIC TESTS									
<p><b>Osteopenia</b></p> <ul style="list-style-type: none"> <li>• Postmenopausal women and men aged <math>\geq 50</math> years T-score <math>-1</math> to <math>\geq -2.5</math></li> <li>• Premenopausal women and men aged <math>&lt; 50</math> years Z-score <math>\leq -2</math></li> </ul> <p><b>Osteoporosis</b></p> <ul style="list-style-type: none"> <li>• Postmenopausal women and men aged <math>\geq 50</math> years T-score <math>&lt; -2.5</math></li> <li>• Premenopausal women and men aged <math>&lt; 50</math> years Z-score <math>\leq -2</math> and fragility fracture</li> </ul>	<ul style="list-style-type: none"> <li>• Reduced bone mass</li> <li>• Increased risk of fractures</li> <li>• Asymptomatic until fractures occur</li> </ul> <p>Common in HIV</p> <ul style="list-style-type: none"> <li>• Up to 60% prevalence of osteopenia</li> <li>• Up to 10-15% prevalence of osteoporosis</li> <li>• Aetiology multifactorial</li> </ul>	<p>Consider classic risk factors<sup>i</sup></p> <p>Assess risk score or need for DXA of spine and hip using FRAX® (<a href="http://www.shef.ac.uk/FRAX">www.shef.ac.uk/FRAX</a>)</p> <ul style="list-style-type: none"> <li>- Only use if <math>&gt;40</math> years</li> <li>- May underestimate risk in HIV patients</li> <li>- Consider using HIV as secondary cause of osteoporosis<sup>ii</sup></li> <li>- Assess risk biannually</li> </ul> <p>If not using FRAX® consider DXA in any patient with <math>\geq 1</math> of:<sup>iii</sup></p> <ol style="list-style-type: none"> <li>1. Postmenopausal women</li> <li>2. Men <math>\geq 50</math> years</li> <li>3. History of low impact fracture or high risk for falls<sup>iv</sup></li> <li>4. Hypogonadism</li> <li>5. Oral glucocorticoid use (minimum 5mg prednisone equivalent for <math>&gt;3</math> months)</li> </ol>	<p><b>DXA scan</b></p> <p><b>Rule out secondary causes if BMD abnormal<sup>v</sup></b></p> <p><b>Lateral spine Xrays if low BMD</b> (lumbar and thoracic)</p>									
<b>Osteomalacia</b>	<ul style="list-style-type: none"> <li>• Defective bone mineralisation</li> <li>• Increased risk of fractures and bone pain</li> <li>• Vitamin D deficiency may cause proximal muscle weakness</li> <li>• High prevalence (<math>&gt;80\%</math>) of vitamin D insufficiency in some HIV cohorts</li> </ul>	<ul style="list-style-type: none"> <li>• Dietary deficiency</li> <li>• Lack of sunlight exposure</li> <li>• Dark skin</li> <li>• Malabsorption</li> <li>• Renal phosphate wasting</li> </ul>	<p>Measure 25-OH vitamin D in all patients</p> <table> <thead> <tr> <th></th> <th>ng/ml</th> <th>nmol/L</th> </tr> </thead> <tbody> <tr> <td><b>Deficiency</b></td> <td><math>&lt;10</math></td> <td><math>&lt;25</math></td> </tr> <tr> <td><b>Insufficiency</b></td> <td><math>&lt;20</math></td> <td><math>&lt;50</math></td> </tr> </tbody> </table> <p>If low, check serum calcium, phosphate, alkaline phosphatase and PTH levels</p> <p>If hypophosphataemic, consider Fanconi syndrome (<a href="#">page 58</a>)</p>		ng/ml	nmol/L	<b>Deficiency</b>	$<10$	$<25$	<b>Insufficiency</b>	$<20$	$<50$
	ng/ml	nmol/L										
<b>Deficiency</b>	$<10$	$<25$										
<b>Insufficiency</b>	$<20$	$<50$										
<b>Osteonecrosis</b>	<ul style="list-style-type: none"> <li>• Infarct of epiphyseal plate of long bones resulting in acute bone pain</li> <li>• Rare but increased prevalence in HIV</li> </ul>	<p><b>Risk factors:</b></p> <ul style="list-style-type: none"> <li>- Advanced HIV disease (low CD4+ T-cell counts)</li> <li>- Glucocorticoid exposure</li> <li>- Intravenous drug use</li> </ul>	<b>MRI</b>									

i Classic risk factors: older age, female gender, hypogonadism, family history of hip fracture, low BMI ( $\leq 19$  kg/m<sup>2</sup>), vitamin D deficiency, smoking, physical inactivity, history of low impact fracture, alcohol excess ( $>3$  units/day), steroid exposure (minimum prednisone 5mg or equivalent for  $>3$  months)

ii Although use of HIV as a secondary risk factor in FRAX® has not been validated, including HIV as a secondary cause in a risk assessment will help identify those patients NOT requiring further assessment / DXA

iii If T-score normal, repeat after 3-5 years in groups 1 and 2, no need for re-screening with DXA in groups 3 & 4 unless risk factors change and only rescreen group 5 if steroid use ongoing

iv Falls Risk Assessment Tool (FRAT) ([www.health.vic.gov.au/agedcare/maintaining/falls/downloads/ph\\_frat.pdf](http://www.health.vic.gov.au/agedcare/maintaining/falls/downloads/ph_frat.pdf))

v Hyperparathyroidism, hyperthyroidism, malabsorption, hypogonadism / amenorrhoea, autoimmune disease, diabetes mellitus, chronic liver disease

**Management of osteoporosis and vitamin D deficiency**

<b>Vitamin D replacement</b>	<ul style="list-style-type: none"> <li>• Suggested regimens for vitamin D replacement:             <ul style="list-style-type: none"> <li>- 800-2,000 IU daily</li> <li>- Can be provided according to national recommendations / availability of preparations (oral and parenteral formulations)</li> <li>- Aim to increase serum 25-OH vitamin D &gt;50nmol/L and maintain serum PTH levels within normal range</li> <li>- Combine with calcium where there is insufficient dietary calcium intake</li> </ul> </li> </ul>
<b>Reducing risk of fractures</b>	<ul style="list-style-type: none"> <li>• Decrease falls by addressing falls risks</li> <li>• Ensure sufficient dietary calcium (1-1.2g daily) and vitamin D (800-2,000 IU daily) intake</li> <li>• Refer to national / regional guidelines on treatment of osteoporosis             <ul style="list-style-type: none"> <li>- if no guidelines available consider bisphosphonate<sup>i</sup> treatment in all osteoporotic postmenopausal women and men &gt; 50 years old and those with a history of fragility fracture</li> <li>- use bisphosphonate<sup>i</sup> with calcium and vitamin D replacement</li> <li>- no significant interactions between bisphosphonates<sup>i</sup> and antiretrovirals</li> <li>- If on TDF consider renal bone disease (<a href="#">p. 58</a>)</li> </ul> </li> <li>• In complicated osteoporotic cases (e.g. young men, premenopausal women, recurrent fracture despite bone protective therapy) refer to endocrinologist</li> <li>• If osteoporotic and on bisphosphonate<sup>i</sup> treatment, repeat DXA after 2 years</li> </ul>

i Bisphosphonate treatment with either of: Alendronate 70 mg once weekly po; Risedronate 35 mg once weekly po; Ibandronate 150mg oral monthly or 3mg i.v. every 3 months; Zoledronate 5 mg i.v. once yearly

## Depression: diagnosis and management

### Significance

- Higher prevalence of depression in HIV-infected patients (20-40% versus 7% in general population) due to stigma, sexual dysfunction, side effects of cART, co-morbidities
- Significant disability associated with depression

### Screening and diagnosis

Who ?	How to screen ?	How to diagnose
Risk population <ul style="list-style-type: none"> <li>• Positive history of depression in family</li> <li>• Depressive episode in personal history</li> <li>• Older age</li> <li>• Adolescence</li> <li>• Patients with history of drug addiction, psychiatric, neurologic or severe somatic co-morbidity</li> <li>• Use of EFV</li> </ul>	<ul style="list-style-type: none"> <li>• Screen every 1-2 years</li> <li>• Two main questions:               <ol style="list-style-type: none"> <li>1. Did you feel frequently depressed, sad and without hope in the last months?</li> <li>2. Were you uninterested in undertaking something in the last month?</li> </ol> </li> <li>• Special symptoms in men:               <ul style="list-style-type: none"> <li>- Stressed, burn out, angry outbursts, coping through work or alcohol</li> <li>- Rule out organic cause (hypothyroidism, Addison's disease, non-HIV drugs, Vit B12 deficiency)</li> </ul> </li> </ul>	Symptoms – evaluate regularly with screening questions <ol style="list-style-type: none"> <li>A. At least 2 weeks of depressed mood OR</li> <li>B. loss of interest OR</li> <li>C. diminished sense of pleasure</li> </ol> PLUS 4 of 7 of the following: <ol style="list-style-type: none"> <li>1. Weight change of <math>\geq 5\%</math> in one month or a persistent change of appetite,</li> <li>2. insomnia or hypersomnia in most days,</li> <li>3. changes in psychomotor state,</li> <li>4. fatigue,</li> <li>5. feelings of guilt and worthlessness,</li> <li>6. diminished concentration and decisiveness,</li> <li>7. suicidal ideation or a suicide attempt</li> </ol>

### Management

Degree of depression	Number of symptoms (see diagnosis: A-C + 1-7)	Treatment	Refer to expert
No	< 4		
Mild	4	problem focused consultation, consider antidepressive treatment, recommend physical activity	<ul style="list-style-type: none"> <li>• Severe depression</li> <li>• Depression not responding to treatment</li> <li>• Suicidal ideation</li> <li>• Complex situations such as drug addiction, anxiety disorders, personality disorders, dementia, acute severe life event</li> </ul>
Intermediate	5-6	start antidepressive treatment, consider referral	
Severe	>6	refer to expert	

- i Maximum effectiveness reached after 10 weeks, one episode usually 6 months treatment;  
optimize treatment, i.e. increase dosage or change drug if side effects;  
partial or no response after 4-6 weeks of antidepressant treatment at adequate dosage: reassess diagnosis;  
depression in persons  $\geq 65$  years generally requires relatively low doses of antidepressants;  
preferred antidepressants for HIV-infected patients: sertraline, paroxetine, venlafaxine, citalopram, mirtazapin, but also other antidepressants may be given. Citalopram may be preferred because of low interactions. For classification, doses, safety and side effects of antidepressants, see [www.europeanaidssociety.org/guide/index.htm](http://www.europeanaidssociety.org/guide/index.htm).  
For interactions with antidepressants see [www.hiv-druginteractions.org](http://www.hiv-druginteractions.org) and [www.europeanaidssociety.org/guide/index.htm](http://www.europeanaidssociety.org/guide/index.htm)

### Hyperlactataemia: diagnosis, prevention and management

Risk factors	Prevention / Diagnosis	Symptoms
<ul style="list-style-type: none"> <li>Use of ddl&gt; d4T &gt; ZDV</li> <li>HCV/HBV co-infection</li> <li>Use of ribavirin</li> <li>Liver disease</li> <li>Low CD4 cell count</li> <li>Pregnancy</li> <li>Female sex</li> <li>Obesity</li> </ul>	<ul style="list-style-type: none"> <li>Avoid d4T + ddl combination</li> <li>Routine monitoring of serum lactate levels not recommended - does <u>not</u> predict risk of lactic acidosis.</li> <li>Measurement of serum lactate, bicarbonate &amp; arterial blood gases-pH indicated in case of symptoms suggestive of hyperlactataemia</li> <li>Close monitoring for symptoms if &gt; 1 risk factor</li> </ul>	<ul style="list-style-type: none"> <li>Hyperlactataemia: unexplained nausea, abdominal pain, hepatomegaly, elevated ALT and/or AST, weight loss</li> <li>Acidaemia: asthenia, dyspnoea, arrhythmias</li> <li>Guillain-Barré-like syndrome</li> </ul>

#### Management

Serum Lactate (mmol/L)	Symptoms	Action
>5 <sup>i</sup>	Yes/No	<ul style="list-style-type: none"> <li>Repeat test under standardized conditions to confirm &amp; obtain arterial pH and bicarbonate<sup>i</sup></li> <li>If confirmed, exclude other causes                             <ul style="list-style-type: none"> <li>- Arterial pH ↓ and/or bicarbonate ↓: Stop NRTIs</li> <li>- Arterial pH and/or bicarbonate normal: Consider switch from high to low risk NRTI &amp; monitor carefully OR Stop NRTI's</li> </ul> </li> </ul>
2-5	Yes	Exclude other causes; if none found: watchfully follow up OR consider switch from high to low risk NRTI, OR Stop NRTI
2-5	No	Repeat test <ul style="list-style-type: none"> <li>- if confirmed: watchfully follow up</li> </ul>
<2		None

<sup>i</sup> Lactic acidosis is a rare but life-threatening situation usually associated with symptoms; high risk if serum lactate > 5 and especially > 10 mmol/L.

#### Management of lactic acidosis (irrespective of serum-lactate level):

Admit patient. Stop NRTIs. Provide intravenous fluids. Vitamin supplementation can be used (vitamin B complex forte 4 ml bid, riboflavin 20 mg bid, thiamine 100 mg bid; L-carnitine 1000 mg bid), although benefit is unproven

### Kidney disease: diagnosis, prevention and management

		eGFR		
		≥60 ml/min	30-59 ml/min <sup>i</sup>	<30 ml/min <sup>i</sup>
Proteinuria <sup>ii</sup> / microhaematuria	UP/C <sup>iii</sup> <50 or UA/C <sup>iv</sup> <30	Regular Follow-up <sup>v</sup>	<ul style="list-style-type: none"> <li>Check risk factors for CKD and nephrotoxic medication</li> <li>Discontinue or adjust drug dosages where appropriate<sup>vi</sup></li> <li>Perform renal ultrasound</li> <li>If haematuria present with any level of proteinuria refer to nephrologist; otherwise consider referral</li> </ul>	<ul style="list-style-type: none"> <li>Discontinue or adjust drug dosages where appropriate<sup>vi</sup></li> <li>Perform renal ultrasound</li> <li>Refer to nephrologist</li> </ul>
	UP/C <sup>iii</sup> 50-100 or UA/C <sup>iv</sup> 30-70	- haematuria		
	UP/C <sup>iii</sup> >100 or UA/C <sup>iv</sup> >70	+ haematuria		

- <sup>i</sup> If not previously known to have CKD reassess within 2 weeks
- <sup>ii</sup> Proteinuria defined as persistent if confirmed on ≥2 occasions >2-3 weeks apart
- <sup>iii</sup> UP/C in spot urine (mg/mmol): detects total urinary protein secondary to glomerular and tubular disease
- <sup>iv</sup> UA/C in spot urine (mg/mmol): predominantly detects glomerular disease. Use in patients with diabetes mellitus
- <sup>v</sup> Check risk factors for CKD, and repeat eGFR and urinalysis as per screening table ([see p. 32](#))
- <sup>vi</sup> Dose modification of ARVs in case of impaired renal function: see [www.eacs.eu/guide/index.htm](http://www.eacs.eu/guide/index.htm)

#### Management of nephropathy in HIV-positive patients<sup>i</sup>

Prevention of progressive renal disease	Comment
1. Antiretroviral therapy	Start ART immediately where HIV-associated nephropathy (HIVAN) <sup>ii</sup> or HIV immune complex disease strongly suspected. Renal biopsy to confirm histological diagnosis recommended
2. Start ACE inhibitors or angiotensin-II receptor antagonists if: <ul style="list-style-type: none"> <li>a) Hypertension, and/or</li> <li>b) Proteinuria</li> </ul>	Monitor eGFR and K+ level closely on starting treatment or increasing dose a) Blood pressure target: <130/ 80 mmHg
3. General measures: <ul style="list-style-type: none"> <li>a) Avoid nephrotoxic drugs</li> <li>b) Life style measures (smoking, weight, diet)</li> <li>c) Treat dyslipidaemia<sup>iii</sup> and diabetes<sup>iii</sup></li> <li>d) Adjust drug dosages where necessary</li> </ul>	CKD and proteinuria are independent risk factors for CVD

- <sup>i</sup> Joint management with a nephrologist
- <sup>ii</sup> HIVAN suspected if black ethnicity & UP/C >100 mg/mmol & no haematuria
- <sup>iii</sup> [see p. 49](#) and [47](#)

Screening for tenofovir renal toxicity

Screening	Frequency	Assessment
a) eGFR <sup>i</sup> (aMDDRD) b) serum phosphate c) urine dipstick analysis <sup>ii</sup>  <b>Measure UP/C<sup>iii</sup> if</b> <ul style="list-style-type: none"> <li>decline in eGFR (deterioration &gt;10ml/min compared to pre-tenofovir level &amp; eGFR&lt;90 ml/min)</li> <li>confirmed hypophosphatemia<sup>iii</sup></li> <li>if urine dipstick proteinuria ≥ 1+</li> </ul>	Prior to starting tenofovir, after 2-4 and 12 weeks; then every 3-6 months	<b>Consider stopping tenofovir if:</b> <ul style="list-style-type: none"> <li>Confirmed significant hypophosphatemia of renal origin and no other cause<sup>iv</sup></li> <li>Progressive decline in eGFR and no other cause</li> <li>Confirmed proximal renal tubulopathy / Renal Fanconi syndrome<sup>v</sup></li> </ul>

- i eGFR: estimated glomerular filtration rate, according to aMDDRD.
- ii Some experts advocate UP/C in spot urine for screening. UP/C (mg/mmol) detects total urinary protein including protein of glomerular or tubular origin. The urine dipstick analysis primarily detects albuminuria as a marker of glomerular disease and is inadequate to detect tubular disease.
- iii Serum-phosphate <0.8 mmol/L, or according to local thresholds
- iv Hypophosphatemia is common in HIV infected patients. If secondary to increased urinary phosphate loss in the absence of any other renal cause should be attributed to tenofovir toxicity.  
Stop TDF if <0.3mmol/L  
Consider renal bone disease secondary to proximal tubulopathy, particularly if alkaline phosphatase increased from baseline: measure 25(OH) vitamin D, PTH
- v Indications and tests for proximal renal tubulopathy see online Table ([www.europeanaidsclicinalsociety.org/guide/index.htm](http://www.europeanaidsclicinalsociety.org/guide/index.htm))

Lipodystrophy: prevention and management

LIPOATROPHY	LIPOHYPERTROPHY
<b>Prevention</b> <ul style="list-style-type: none"> <li>Avoid d4T and ZDV or pre-emptively switch away from them</li> </ul> <b>Management</b> <ul style="list-style-type: none"> <li>Modification of ART                             <ul style="list-style-type: none"> <li>Switch d4T or ZDV to ABC or TDF:                                     <ul style="list-style-type: none"> <li>Only ART modification proven to partially restore subcutaneous fat: increase in total limb fat ~400-500g/year</li> <li>Risk of toxicity from new drug (see p. 36):   <ul style="list-style-type: none"> <li>Switch to regimen not including NRTIs</li> <li>Increase in total limb fat ~400-500g/year</li> <li>May increase risk of dyslipidaemia</li> <li>Less data on virological safety</li> </ul> </li> </ul> </li> <li>Surgical intervention                             <ul style="list-style-type: none"> <li>Offered for relief of facial lipodystrophy only</li> </ul> </li> </ul> </li> <li>Pharmacological interventions to treat lipodystrophy have not been proven to be effective and may introduce new complications                             <ul style="list-style-type: none"> <li>Proglitazone - possibly beneficial in patients not taking d4T</li> <li>Rosiglitazone and Pioglitazone - improvement in insulin sensitivity</li> <li>Rosiglitazone: increases in blood lipids and possible IHD.</li> </ul> </li> </ul>	<b>Prevention</b> <ul style="list-style-type: none"> <li>No proven strategy</li> <li>Weight gain expected with effective ART reflecting “healthy” response</li> <li>Weight reduction or avoidance of weight gain may decrease visceral adiposity</li> <li>Avoid inhaled fluticasone with some PI</li> </ul> <b>Management</b> <ul style="list-style-type: none"> <li>Diet and exercise may reduce visceral adiposity; Limited data, but possibly reduction of visceral adipose tissue and improvement in insulin sensitivity and blood lipids, especially in obesity associated with lipohypertrophy</li> <li>No prospective trials in HIV-infected patients to definitely indicate degree of diet and/or exercise needed to maintain reduction in visceral fat.</li> <li>May worsen subcutaneous lipodystrophy</li> <li>Pharmacological interventions to treat lipohypertrophy have not been proven to provide long-term effects and may introduce new complications                             <ul style="list-style-type: none"> <li>Growth hormone<sup>ii</sup> <ul style="list-style-type: none"> <li>Decreases visceral adipose tissue</li> <li>May worsen subcutaneous lipodystrophy, may worsen insulin resistance</li> </ul> </li> <li>Metformin                                     <ul style="list-style-type: none"> <li>Decreases visceral adipose tissue in insulin resistant persons</li> </ul> </li> <li>May worsen subcutaneous lipodystrophy.</li> <li>Surgical therapy can be considered for localised lipomas/buffalo humps                                     <ul style="list-style-type: none"> <li>Duration of effect variable</li> </ul> </li> </ul> </li> </ul>

i See [www.europeanaidsclicinalsociety.org/guide/index.htm](http://www.europeanaidsclicinalsociety.org/guide/index.htm) for list of arguments for and against the use of various types of fillers (with some examples of specific types) and autologous fat transplantation

ii Tesamorelin (growth hormone releasing factor) was shown to reduce visceral adipose tissue volume; the drug is not currently licensed in Europe.

# Work-up and Management of the HIV patient with increased ALT/AST

Identify potential cause of increased liver enzymes, using the following steps:

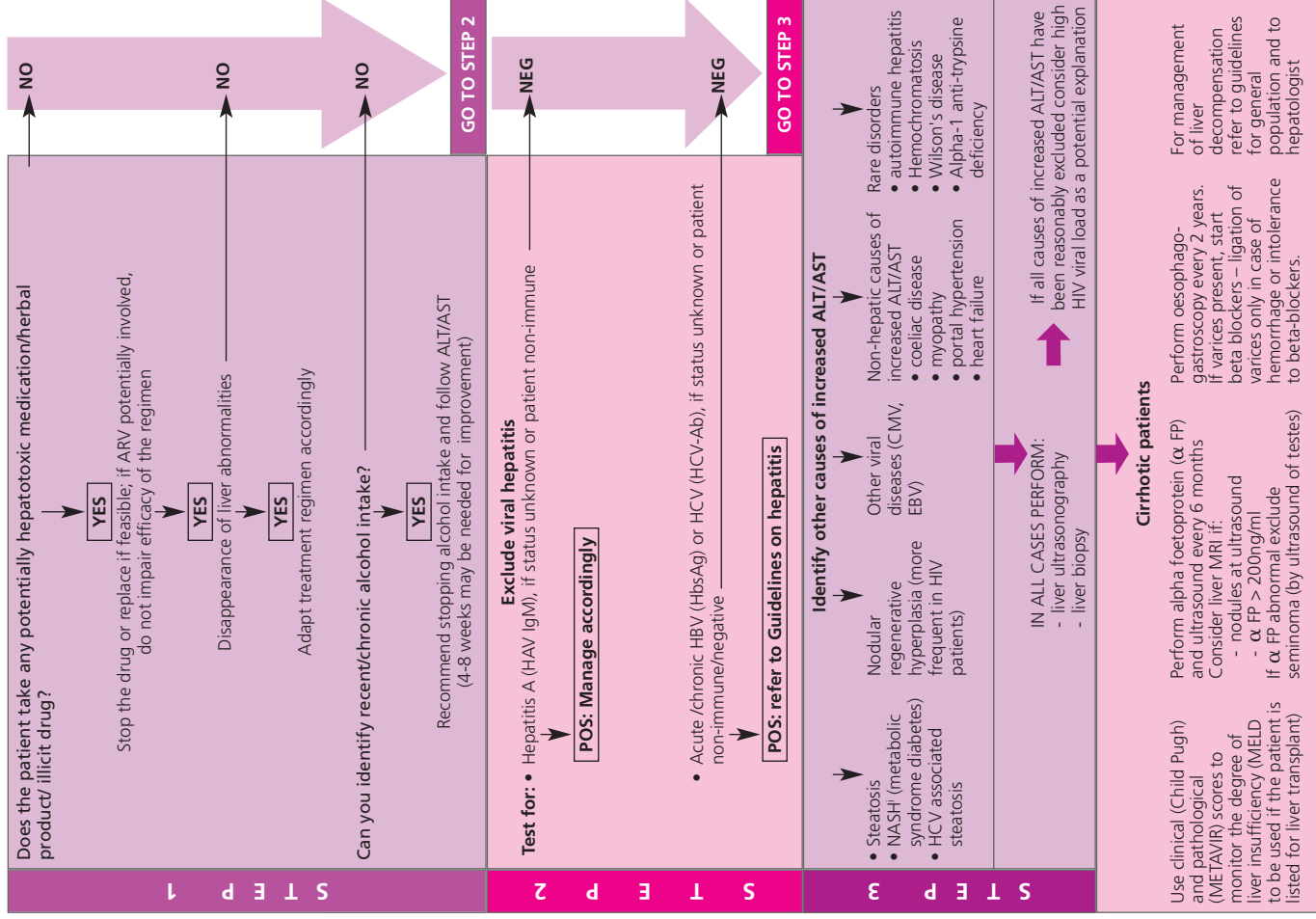

i non alcoholic steato hepatitis

## Neurocognitive impairment: diagnosis and management

Any HIV-infected person complaining of disturbances in his/her memory (comprehension, clarity or speed) should be evaluated extensively, including neurological examination, neuropsychological assessment, cerebrospinal examination and imaging of the brain.

- Patients without such symptoms that should be targeted for screening
  - Uncontrolled HIV infection (detectable plasma HIV RNA)
  - Use of antiretroviral agents with limited CNS penetration
  - Low CD4 nadir (<200 cells/mm<sup>3</sup>)
  - Ongoing depression
- Screening tool
  - International HIV Dementia Scale (IHDS)<sup>i</sup>
- Interventions if neurocognitive impairment detected:
  - If patient is not on ART:
    - Consider initiation of ART in which at least 2 drugs penetrate CNS<sup>ii</sup>
    - Consider risk for antiretroviral resistance if prior virological failure
  - If patient is already on ART:
    - Consider changing antiretroviral treatment to active drugs with better CNS penetration<sup>ii</sup>
    - Consider genotyping of plasma and CSF HIV RNA whenever feasible prior to changing ART

i See [www.europeanaidsclinicalsociety.org/guide/index.htm](http://www.europeanaidsclinicalsociety.org/guide/index.htm) for components of the IHDS scale

ii See [www.europeanaidsclinicalsociety.org/guide/index.htm](http://www.europeanaidsclinicalsociety.org/guide/index.htm) for list of drugs with favourable and poor CNS penetration

European AIDS Clinical Society

# Guidelines

Clinical management and treatment  
of chronic hepatitis B and C  
co-infection in HIV-infected adults



## Index

- Panel members ..... 68
- General recommendations for counselling in patients with HIV and hepatitis co-infection ..... 69
- [Figure 1](#): Assessment of treatment indication for HBV infection in HIV-positive individuals ..... 72
- [Figure 2](#): Treatment of chronic HBV infection in HIV-positive individuals ..... 74
- Treatment recommendations for therapy of hepatitis C in HIV co-infection ..... 76
- [Table 1](#): Diagnostic procedures for hepatitis C in HIV co-infection ..... 78
- [Figure 3](#): Proposed optimal duration of HCV therapy in HCV/HIV co-infected patients. .... 79
- [Table 2](#): Classification of and interventions for HCV/HIV-co-infected non-responders/ relapsers to prior interferon-based therapies ..... 80

These Euroguidelines result from the short statement of the first European Consensus conference on the treatment of chronic hepatitis B and C in HIV co-infected patients. *J Hepatol* 2005; 42:615-624, the updated recommendations from the HCV-HIV International Panel (Soriano V, Puoti M, Sulkowski M, Cargnel A, Benhamou Y, Peters M, Mauss S, Bräu N, Hatzakis A, Pol S, Rockstroh J. Care of patients coinfecting with HIV and hepatitis C virus: 2007. *AIDS*. 2007;21:1073-1089), the previ-

ous recommendations from the hepatitis panel of the European AIDS Clinical Society (JK Rockstroh, S Bhagani, Y Benhamou, R Bruno, S Mauss, L Peters, M Puoti, V Soriano, C Tural and the EACS Executive Committee. European AIDS Clinical Society (EACS) guidelines for the clinical management and treatment of chronic hepatitis B and C coinfection in HIV-infected adults. *HIV Medicine* 2008; 9, 82–88) and from a discussion with the following panel:

### Panel Members

Jürgen Rockstroh,  
Bonn, *Germany*  
Chair

Yves Benhamou,  
Paris, *France*

Sanjay Bhagani,  
London, *United Kingdom*

Raffaele Bruno,  
Pavia, *Italy*

Diego García,  
Alicante, *Spain*

Stefan Mauss,  
Duesseldorf, *Germany*

Lars Peters,  
Copenhagen, *Denmark*

Massimo Puoti,  
Brescia, *Italy*

Vicente Soriano,  
Madrid, *Spain*

Cristina Tural,  
Barcelona, *Spain*

and the EACS Executive Committee

## General recommendations for counselling in patients with HIV and hepatitis co-infection

### SCREENING

1. All HIV-infected patients should be screened for hepatitis C at diagnosis and then on an annual basis. Screening for HCV in HIV infected patients should be done using anti-HCV antibody test. A positive result should be followed by evaluation for the presence of HCV-RNA and the genotype should be determined. Patients with risk factors (ongoing IVDU, mucosal traumatic sex; ongoing unprotected anal intercourse, recent sexually transmitted infection) with unexplained increase in hepatic transaminases and a negative HCV antibody test should be offered an HCV-RNA test for early detection of a recent infection.
2. HIV-infected patients should be screened for hepatitis A and B. Patients from high prevalence countries for HBV, in particular those with elevated liver transaminases should be screened for HBV-DNA in addition to HBs Ag to rule out occult HBV infection.
3. Hepatitis delta antibodies should be screened for in all HBsAg+ patients.
4. Patients with liver cirrhosis should be screened at 6-monthly intervals with serum alpha-fetoprotein and hepatic ultrasound for the occurrence of hepatocellular carcinoma. Routine screening is also advised for

oesophageal varices at the time of diagnosis and at 1 – 2 year intervals thereafter.

### VACCINATION

5. Patients lacking anti-HAV IgG antibodies or anti-HBs antibodies should be offered vaccination for the respective virus to prevent infection regardless of their CD4-count. The response to the HBV vaccine is influenced by the CD4-count and level of HIV-RNA. In patients with low CD4-counts (<200/μl) and ongoing HIV replication, HAART should be initiated first prior to respective vaccination. Patients anti-HBc positive and anti-HBs negative should be tested for anti-HBs response 2 – 4 weeks after a first HBV vaccination and may skip remaining vaccinations in case of sufficient anti-HBs response (anti-HBs > 10 IU/l).

In case of insufficient response (anti-HBs < 10 IU/l) revaccination should be considered. Double dose revaccination (40μg) at 3-4 vaccination time points (months 0, 1, 6 and 12) may help to improve response rates to HBV vaccination. Patients who fail to seroconvert after hepatitis B vaccination and remain at risk for HBV-infection should have annual serological tests for evidence of HBV infection.

**HAART:**

6. Hepatitis B and/or C co-infected patients benefit from early HAART because liver fibrosis progression is reduced with immune reconstitution and suppression of HIV-RNA. Stopping HAART has been associated with enhanced risk for AIDS and non-AIDS related events in the SMART study and this risk was enhanced for patients with hepatitis co-infection. Particular prudence is warranted in HIV/HBV co-infected patients who stop anti-HBV containing HAART.

**END STAGE LIVER DISEASE (ESLD):**

7. HIV-positive patients require the same measures for the treatment of oesophageal varices, hepatorenal syndrome, hepatic encephalopathy or ascites as HIV-negative patients.

8. HIV-coinfected patients who suffer from ESLD warrant particular attention in the management of liver insufficiency. Apart from considerations of treatment of HBV or HCV, antiretrovirals metabolized via the liver may need to be dose adjusted and in individual cases therapeutic drug monitoring of the respective drug is advisable.

9. Creatinine clearance using Cockcroft Gault estimation in the setting of advanced or decompensated liver cirrhosis overestimates the true glomerular filtration rate and use of the arithmetic mean urea and creatinine clearance or inulin clearance is recommended.

10. Patients with a MELD-score > 15, CD4-cell count > 100/ $\mu$ l and options for efficacious and durable HAART should be evaluated for liver transplantation (OLT). OLT outcomes in HIV/HBV coinfected patients are particularly promising, whereas post-transplant survival in HIV/HCV co-infected patients has been somewhat lower than in HCV-monoinfected patients mainly due to the complicated course of HCV re-infection after transplantation.

**PREVENTION/SUPPORT**

11. Psychiatric, psychological, social and medical support should be made available to patients with a high alcohol intake to stop drinking or to limit alcohol consumption.

12. Substitution therapy (opioid replacement therapy) in patients with active drug abuse as a step towards cessation of active drug use should be considered; help provided (e.g. through needle- and syringe-exchange programs) reduces the risk of re-infection including parenteral viral transmission (harm reduction strategy).

13. Since HBV and HIV and occasionally HCV are transmitted sexually, adequate counselling including the use of condoms is advisable. Information on the risk of HCV transmission due to mucosal traumatic sexual practices associated with a high likelihood of blood contact should be provided and risk reduction should be discussed.

**Figure 1:** Assessment of treatment indication for HBV infection in HIV-positive individuals

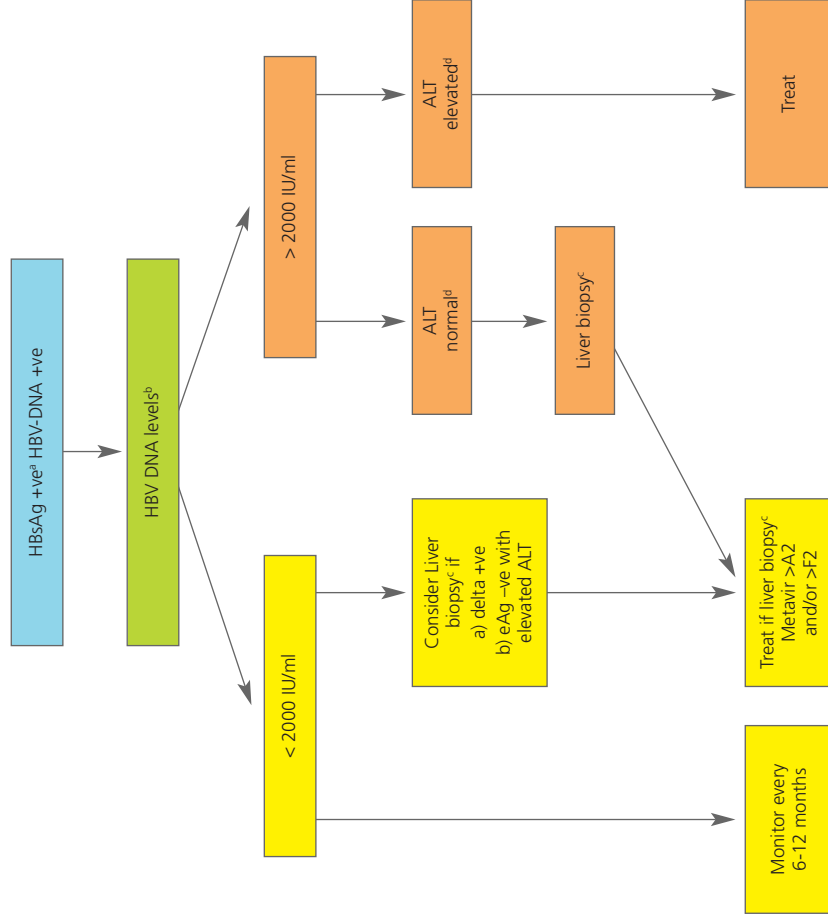

- a) Chronic HBV-infection defined as HBsAg or HBV-DNA positive > 6 months
- b) Serum HBV-DNA levels have been demonstrated to be associated with a linear increased risk for development of liver cirrhosis and HCC; please note that the conversion from copies to IU/ml varies depending on which test assay was used; in general 1 IU/ml equals around 5 copies or genome equivalents; one picogram HBV-DNA equals  $2.8 \times 10^5$  genome/ml
- c) Patients with replicating HBV and normal liver enzymes may have significant liver damage, therefore consider assessment of liver damage; this may be done using either liver biopsy or non-invasive tools, including serum fibrosis markers or FibroScan. Non-invasive methods for the evaluation of liver fibrosis are not fully validated in patients with Hepatitis B (especially in those with normal liver enzymes) and proposed cut offs are not the same as identified in patients with hepatitis C. While liver biopsy may provide additional information on inflammation and other lesions (e.g. steatosis), non-invasive markers can be used at more frequent intervals.
- d) Please note normal ALT is < 19 IU/l for women, and < 31 IU/l for men

**Figure 2:** Treatment of chronic HBV infection in HIV-positive individuals

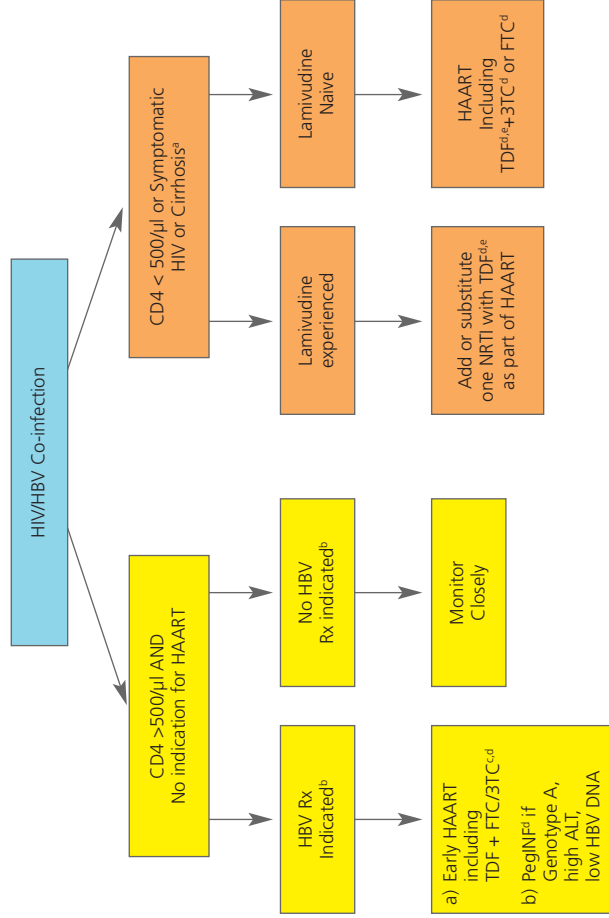

- a) Cirrhotic patients should be referred for variceal assessment, have regular HCC monitoring and should be referred early for transplant assessment. Patients with liver cirrhosis and low CD4-counts require careful surveillance in the first months after starting HAART in order not to overlook immune-reconstitution syndrome and subsequent liver decompensation due to flares of liver enzymes.
- b) See Figure 1 for assessment of HBV Rx indication. Some experts strongly believe that any HBV-infected patient requiring HAART should receive TDF + 3TC or FTC unless history of TDF intolerance, particularly in HIV/HBV co-infected patients with advanced liver fibrosis (F3/F4).
- c) Antiretroviral naive Asian, HBe-Ag+, HIV coinfectd patients initiating HAART with TDF or TDF+FTC reached unexpected high rates of HBe (and even Hbs) seroconversion, strengthening the rationale for early HAART. If a patient is unwilling to go on early HAART, adefovir and telbivudine may be used as an alternative to control HBV alone. A recent case report suggested possible anti-HIV activity of telbivudine. In-vitro data using an assay which was able to demonstrate anti-HIV-activity of entecavir however, failed to detect an influence of telbivudine on the replicative capacity of HIV-1.
- d) Treatment length: 48 weeks for Peg-IFN; recent data suggests that on-treatment quantification of HbsAg in patients with HBeAg-negative chronic hepatitis B treated with Peg-IFN may help identify those likely to be cured by this therapy and optimize treatment strategies. The optimal treatment duration for nucleos(t)ide analogues with anti-HBV activity has not yet been determined and experts recommend life-long therapy if anti-HBV nucleos(t)ides are given as part of HAART. Patients not requiring HAART and on treatment with telbivudine +/- adefovir, or those on HAART where nucleoside back-bone needs changing, anti-HBV therapy may be stopped cautiously in HBeAg+ patients who have achieved HBe-seroconversion for at least six months or, after confirmed Hbs-seroconversion in those who are HBeAg-, in patients with liver cirrhosis a stop of effective anti-HBV treatment is not recommend to avoid liver decompensation due to flares of liver enzymes.
- e) In some cases of tenofovir intolerance (i.e. renal disease), entecavir + adefovir or tenofovir in doses adjusted to renal clearance in combination with effective HAART may be advisable. NRTI substitution should only be performed if feasible and appropriate from the perspective of maintaining HIV suppression. Caution is warranted to switch from a tenofovir based regimen to drugs with a lower genetic barrier, e.g. FTC/3TC, in particular in lamivudine pretreated cirrhotic patients as viral breakthrough due to archived YMDD mutations has been observed. This has also been described in individuals with previous 3TC HBV-resistance who have been switched from tenofovir to entecavir.

## Treatment recommendations for therapy of hepatitis C in HIV co-infection

1. HCV treatment offers the possibility of eradicating HCV within a defined treatment period. This is potentially advantageous for the subsequent management of the patient with HIV, and every co-infected patient should therefore be considered for treatment when the benefits of therapy outweigh the risks. This also needs to be seen in the context of faster liver fibrosis progression in HIV/HCV co-infection and with better HCV treatment outcome with improved management in these patients.
2. Information on liver fibrosis staging is important for making therapeutic decisions in co-infected patients. However, a liver biopsy is not mandatory for considering treatment of chronic HCV. Current therapy is particularly recommended in patients with a high likelihood of achieving sustained virological response (SVR): genotypes 2 or 3 and patients infected with genotype 1 if the viral load is low (<400,000 IU/ml). More recently, insulin resistance (which can be determined using the homeostasis model assessment of insulin resistance HOMA IR) has been repeatedly reported as a negative predictor of achievement of SVR and therefore may also be considered during pre-treatment evaluation and, if possible, should be effectively managed before treating HCV infection.
3. In case of the availability of a liver biopsy or FibroScan demonstrating lower stages of liver fibrosis (F0-1), regardless of HCV genotype, treatment can be deferred. In these cases, fibrosis assessment should be carried out at frequent intervals to monitor for fibrosis progression. A liver disease stage assessment is especially important to perform in patients with a low chance of SVR.
4. The combination of Peg-IFN alpha and ribavirin (RBV) is the treatment of choice for HCV infection. The standard dose for Peg-IFN 2a is 180 µg once weekly, and for Peg-IFN 2b it is 1.5 µg/kg bodyweight once weekly. An initial weight adapted dose of RBV of 1000 (wt ≤ 75kg) - 1200 (wt > 75kg) mg/day (administered bid) is recommended for all HCV genotypes in the HIV setting.
5. The primary aim of anti-HCV treatment is sustained virological response defined as undetectable serum HCV-RNA 24 weeks after the end of therapy, evaluated using sensitive molecular tests.
6. If chronic hepatitis C is detected early in the course of HIV infection (before the initiation of HAART is necessary), treatment for chronic HCV is advised. However, if a co-infected patient has significant immunodeficiency (CD4 count < 350 cells/µl), the CD4 count should be improved using HAART prior to commencing anti-HCV treatment. Patients with a CD4 relative percentage >25% are more likely to achieve SVR than lower CD4 percentage.
7. If an early virological response (decline of at least 2 log<sub>10</sub> reduction in HCV-RNA at week 12 compared to baseline) is not achieved, treatment should be stopped (figure 3).
8. During Peg-IFN plus ribavirin therapy, ddl is contraindicated in patients with cirrhosis and should be avoided in patients with less severe liver disease. D4T and AZT should also be avoided if possible. The role of abacavir is uncertain at this point but cohort data suggests lower SVR results in patients receiving abacavir containing HAART. Data investigating RBV plasma levels have shown that the interaction between abacavir and ribavirin may be negligible if weight based ribavirin is used.
9. In patients with acute HCV infection, HCV therapy is recommended if HCV-RNA is confirmed positive (1 week apart) by week 12 post HCV transmission, as SVR rates following treatment of acute HCV-infection are higher than for treatment of chronic HCV. Most experts recommend therapy for 24 weeks with Peg-IFN and ribavirin; however the duration of therapy and use of ribavirin is currently under discussion. HCV-RNA levels at week 4 and 12 may help to guide treatment duration.

**Table 1: Diagnostic procedures for hepatitis C in HIV co-infection**

Diagnosis of hepatitis C
HCV-Ab (positive 1-5 months after infection, may rarely be lost with immunosuppression)
HCV-RNA levels <sup>a</sup> (in particular important for the prediction of response to treatment)
<b>Status of liver damage</b>
Grading of fibrosis (e. g. FibroScan, liver biopsy, serum fibrosis markers <sup>b</sup> )
Hepatic synthetic function (e. g. coagulation, albumin, CHE)
Ultrasound and AFP every 6 months in cirrhotics (gastroscopy upon diagnosis of cirrhosis and every 1-2 years thereafter)
<b>Before HCV treatment</b>
HCV genotype and serum HCV-RNA
Autoantibodies (ANA, LKM1) <sup>c</sup>
TSH, thyroid autoantibodies
<b>Monitoring of HCV treatment</b>
Differential blood count and liver enzymes every 2-4 weeks
HCV-RNA at week 4 (to evaluate rapid virological response), and weeks 12, 24, and 48 (72 if applicable) and 24 weeks after stopping HCV therapy
CD4-count every 12 weeks
TSH every 12 weeks

- Low viral load defined as less than 400,000 – 500,000 IU/ml when using PegINF+RBV. There is no standard conversion formula for converting the amount of HCV-RNA reported in copies/ml to the amount reported in IU/ml. The conversion factor ranges from about one to five HCV-RNA copies per IU/ml.
- Serum fibrosis markers include APRI, FIB-4, Hyaluronic acid, Fibrometer, Fibrotest, Forns, Hepascore and other indices; recently more complex tests such as Fibrometer, Fibrotest and Hepascore have shown to more accurately predict liver fibrosis than simple biochemical tests such as APRI, FIB-4 or Forns.
- Patients with positive anti LKM or ANA with homogeneous pattern should be evaluated for concurrent autoimmune hepatitis especially in the presence of ALT elevation during treatment.

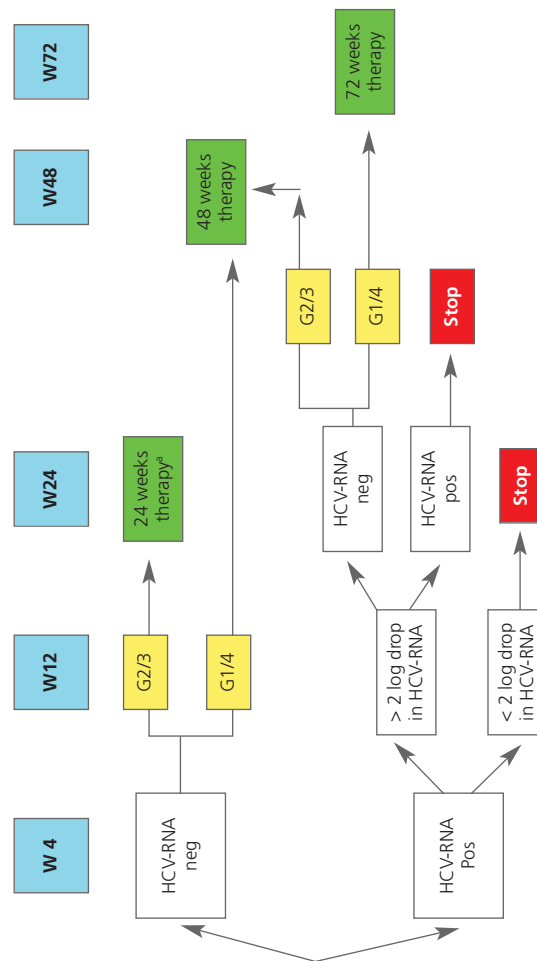
**Figure 3: Proposed optimal duration of HCV therapy in HCV/HIV co-infected patients**

a) In patients with baseline low viral load (<400 000 IU/ml) and minimal liver fibrosis.

**Table 2:** Classification of and interventions for HCV/HIV-co-infected non-responders/ relapsers to prior interferon-based therapies

CATEGORY	SUBGROUP	SUGGESTED INTERVENTION
<b>Suboptimal treatment</b>	Suboptimal schedule <ul style="list-style-type: none"> <li>• Interferon (monotherapy or with ribavirin)</li> <li>• Low ribavirin dose</li> <li>• Short length of therapy</li> </ul>	Re-treatment using combination therapy with Peg-INF plus weight-based ribavirin dosing
	Limiting toxicities & poor adherence	Optimal support (SSRI, paracetamol/ NSAID, adherence support, use of hematopoietic growth factors <sup>a)</sup> )
<b>Optimal treatment with virological failure</b>	Relapse (HCV-RNA negative at the end of treatment)	Re-treatment using combination therapy with Peg-INF plus weight-based ribavirin dosing (consider longer treatment duration)
	Non Response (no HCV-RNA negativization during treatment)	Wait until new antivirals become available either through clinical trials or are licensed.

a) Data on the use of hematopoietic growth factors in HIV/HCV co-infection so far is limited to an improvement in quality of life but not antiviral efficacy; treatment with growth factors is currently mostly off-label in Europe.

# EACS

## European AIDS Clinical Society

Hôpital Pitié Salpêtrière - Pavillon Laveran  
47, boulevard de l'hôpital - 75651 - Paris Cédex 13  
T. 33 1 44 24 17 96 - F. 33 1 53 61 13 97

**E-mail :** [sylvie.chatelin@europeanidsclinicalsociety.org](mailto:sylvie.chatelin@europeanidsclinicalsociety.org)

**[www.europeanidsclinicalsociety.org](http://www.europeanidsclinicalsociety.org)**

The European AIDS Clinical Society (EACS) Guidelines are freely downloadable from [www.eacs.eu](http://www.eacs.eu). A declaration of potential conflict of interest of the panel members can be found at the same address.